

UNCLASSIFIED

AD NUMBER

AD007261

LIMITATION CHANGES

TO:

Approved for public release; distribution is unlimited. Document partially illegible.

FROM:

Distribution authorized to U.S. Gov't. agencies and their contractors;
Administrative/Operational Use; DEC 1952. Other requests shall be referred to Chemical Corps, Army Chemical Center, MD. Document partially illegible.

AUTHORITY

ECBC memo dtd 20 Jun 2013

THIS PAGE IS UNCLASSIFIED

UNCLASSIFIED

AD NUMBER
AD007261
CLASSIFICATION CHANGES
TO
unclassified
FROM
secret
AUTHORITY
ASTIA Tab No. U63-4-3, 1 Nov 1963

THIS PAGE IS UNCLASSIFIED

UNCLASSIFIED

AD 7261

DEFENSE DOCUMENTATION CENTER

FOR

SCIENTIFIC AND TECHNICAL INFORMATION

CAMERON STATION, ALEXANDRIA, VIRGINIA

CLASSIFICATION CHANGED
TO UNCLASSIFIED

FROM SECRET

PER AUTHORITY LISTED IN

ASTIA TAB NO. _____ U63-4-3

DATE _____ 1 NOV. 63



UNCLASSIFIED

NOTICE: When government or other drawings, specifications or other data are used for any purpose other than in connection with a definitely related government procurement operation, the U. S. Government thereby incurs no responsibility, nor any obligation whatsoever; and the fact that the Government may have formulated, furnished, or in any way supplied the said drawings, specifications, or other data is not to be regarded by implication or otherwise as in any manner licensing the holder or any other person or corporation, or conveying any rights or permission to manufacture, use or sell any patented invention that may in any way be related thereto.

CHEMICAL CORPS, U. S. ARMY

BEHAVIOR OF AEROSOL CLOUDS WITHIN CITIES

Joint Quarterly Report No. 2

October - December 1952

Submitted by:

Philip A. Leighton

For STANFORD UNIVERSITY
Stanford, California
Contr. No. DA-18-064-cml-1856

Richard B. Dittman

For THE RALPH M. PARSONS COMPANY
Pasadena, California
Contr. No. DA-18-064-cml-2282

Project no. 4-11-04-005

"This material contains information affecting the national defense of the United States within the meaning of the espionage laws, Title 18, U.S.C., Sec. 793 and 794, the transmission or revelation of which in any manner to an unauthorized person is prohibited by law."



DOWNTOWN MINNEAPOLIS LOOKING NORTHEAST
Two-meter isotherms are shown for Temperature Survey X: 27, 28 October at 2100 hours. Note displacement with respect to the built-up area. The wiresonde position is indicated by X.

CONTENTS

	<u>Page No.</u>
TITLE PAGE	1
CONTENTS	3
ILLUSTRATIONS	4
I. SUMMARY	6
A. Preparation for Tests	6
B. Field Measurements and Results	7
II. FIELD OFFICE FACILITIES AND PERSONNEL	9
A. Requirements	9
B. Field Office Facilities	9
C. Field Office Personnel	13
III. INSTRUMENTATION	19
A. Progress	19
B. Portable Wind Direction Indicator	23
C. Aspirated Thermistor Air Temperature Indicator	31
D. Plans	49
IV. FIELD OPERATIONS	61
A. Temperature Survey Procedures	61
B. Temperature Surveys in Minneapolis and St. Louis	62
V. RESULTS AND DISCUSSION	67
A. Summary of Results Obtained from Four Minneapolis Surveys	67
B. Discussion of Urban Thermal Structure	72
C. Application of Temperature Survey Results to Selection of Sites for Aerosol Cloud Studies	85
APPENDIX	88

ILLUSTRATIONS

<u>Figure No.</u>	<u>Title</u>	<u>Page No.</u>
Frontispiece	Downtown Minneapolis	2
II-1	Minneapolis Field Office, Floor Plan	18
III-1	Wind Direction Recorder and Wind Vane	51
III-2	Wind Vane Installation on Meteorological Survey Car	52
III-3	Block Diagram of Wind Direction Recorder	53
III-4	Typical Wind Direction Record	54
III-5	Error Curve of Wind Direction Recorder	54
III-6	Parallel Thermistor Temperature Sensing Element	55
III-7	Simplified Diagram of Temperature Indi- cating Bridge	56
III-8	Schematic Diagram of Temperature Indica- ting Bridge	57
III-9	Aspirated Automobile Thermistor Mounting Unit	58
III-10	Aspirated Aircraft Thermistor Mounting Unit	59
III-11	Temperature Indicating Bridge	60
V-1	Topographic Map, Minneapolis	66
A-1	St. Cloud Raobs, M-25	89
A-2	Temperature Soundings, Minneapolis, M-25	90
A-3	Two-Meter Air Temperature Survey, M-25, 2100 Hours	91

ILLUSTRATIONS (Continued)

<u>Figure No.</u>	<u>Title</u>	<u>Page No.</u>
A-4	St. Cloud Raobs, M-26	92
A-5	Two-Meter Air Temperature Survey, M-26, 2100 Hours	93
A-6	St. Cloud Raobs, M-27	94
A-7	Temperature Soundings, Minneapolis, M-27 . . .	95
A-8	Two-Meter Air Temperature Survey, M-27, 2100 Hours	96
A-9	St. Cloud Raobs, M-29	97
A-10	Two-Meter Air Temperature Survey, M-29, 2000 Hours	98
A-11	Two-Meter Air Temperature Survey, M-29, 2100 Hours	99
A-12	Two-Meter Air Temperature Survey, M-29, 2200 Hours	100

I. SUMMARY

A. PREPARATION FOR TESTS

1. Personnel and Facilities

During the current period, considerable administrative progress was made preparatory to studies of aerosol cloud behavior within Minneapolis and St. Louis. Permanent field offices were established, and thirteen full-time and ninety-four part-time personnel were assigned to these field operations. In the Minneapolis office, which includes a garage for storing and maintaining meteorological and sampling equipment, facilities were set up for fluorescent-particle counting and for data analysis in strict conformity with security regulations. To minimize the possibility of accidentally introduced contamination, arrangements were completed in Minneapolis for the storage of fluorescent material and aerosol-generation equipment at a location remote from the field office.

2. Instrumentation

The design, production, and delivery of meteorological and sampling instruments are nearly complete. Initial experience with wintertime conditions and with the street routes required for proper temperature surveys has resulted in an expanded instrumentation program for Minneapolis. Though preliminary field tests have indicated that equipment will perform according to specification, certain structural modifications have been necessary. Instances of developmental progress are

I. SUMMARY (Continued)

provided in detailed descriptions of the Portable Wind Direction Recorder and the Aspirated Thermistor Air Temperature Indicator.

B. FIELD MEASUREMENTS AND RESULTS

1. The Urban Thermal Structure of Minneapolis

Evaluation was made of four temperature surveys conducted in Minneapolis, including several measurements of vertical temperature gradients. From the resulting twelve isotherm charts, a characteristic urban temperature pattern was determined for Minneapolis. The five soundings in the built-up area, considered with the raob soundings obtained at St. Cloud, indicated a pronounced urban effect on vertical temperature gradient. In its salient features, the temperature structure is comparable to those noted for certain California coastal cities:

(1) Highest temperatures were found in or near the built-up area, while lower temperature readings were obtained near the larger parks or undeveloped areas;

(2) Considerable instability existed within a downtown area at times when inversions probably developed over the area surrounding it;

(3) The greatest urban temperature differential was obtained with clear skies and low wind speeds, and under converse conditions this differential was greatly reduced.

I. SUMMARY (Continued)

(4) Under moderate wind velocities, isotherm patterns were displaced somewhat in the downwind direction.

Though the isotherm pattern did not appear to be affected by below-freezing temperatures, winter surveys are necessary to determine the possible effect of frozen lakes and snow-covered grounds upon temperature pattern.

2. Selection of Sites for Aerosol Cloud Studies

Based on considerations of structure and population density, topography, and mesometeorological survey results, the following four sites have been tentatively selected as desirable areas for aerosol cloud studies employing the fluorescent tracer technique:

- (1) A built-up area, predominantly residential but also comprising commercial structures;
- (2) An area located along the river and comparable to the first site in size, population, and structure density;
- (3) A central downtown district; and
- (4) A flat open area on the outskirts of the city.

The selection of these sites will enable comparative studies for evaluating urban effects. The first two areas, for example, can be paired for determining the possible river effect upon aerosol behavior. Until final selection is made of all field areas, the major testing effort will be devoted to the first site.

II. FIELD OFFICE FACILITIES AND PERSONNEL

A. REQUIREMENTS

The first Joint Quarterly Report discussed the requirements for field office facilities and personnel. It was pointed out that the office should provide space in which the various activities and functions can be performed and should satisfy the requirements imposed by security regulations. The reasons for locating the field office in Minneapolis, with a subordinate office in St. Louis, were explained, and the steps taken to secure adequate space in Minneapolis were outlined.

Joint Quarterly Report No. 1 also discussed the personnel requirements to obtain field test data, to analyze and reduce the data to a usable form, and to perform the administrative duties required by such an operation.

The present section describes the field office facilities that have been established and the personnel assigned to the project to meet organizational requirements.

B. FIELD OFFICE FACILITIES

1. Minneapolis

During October a satisfactory lease agreement was concluded for a piece of property suitable for the Minneapolis field office, located at 918 Third Avenue South, about one-half mile south of the central business

II. FIELD OFFICE FACILITIES AND PERSONNEL (Continued)

district. The building, including a garage in the rear, is one story comprising approximately 2100 square feet of office space and 2700 square feet of garage space. The front entrance is on a main thoroughfare and a 20-foot alley along one side provides ready access to the garage in the rear.

The space was occupied 15 October 1952, at which time the temporary quarters in the Andrus Building at 512 Nicollet Avenue were vacated. Shortly after occupancy the need for partitions was established. These partitions were for the purpose of providing a "Closed Area", a laboratory for preparing and mounting filters, a darkened room for microscopic examination of filters, and a certain degree of privacy. These partitions were completed during December 1952. In November a facility check was made by Mr. Gilbert Ward, Security Officer, Chicago Chemical Procurement District, and clearance has been requested for the handling and storage of documents classified "Secret".

Figure II-1 is a floor plan of the Minneapolis Field Office. Office space is provided for the Assistant Project Engineer, the Chief of Tracer Tests, the Chief of Meteorological Surveys, and the Office Manager. Space for the Office Manager is adjacent to the front door in order to accept delivery of mail and supplies, control admittance of visitors and limit entrance to the "Closed Area" to those persons having proper

II. FIELD OFFICE FACILITIES AND PERSONNEL (Continued)

clearance to this area. Secretarial space is provided adjacent to the Office Manager and secretarial work of a classified nature is performed within the "Closed Area".

Entrance to the "Closed Area" is by a single door from the Office Manager's office. The area comprises space for drafting and computing of classified data, and offices for the Assistant Project Engineer, the Chief of Tracer Tests, and the Chief of Meteorological Surveys. Classified documents are also stored and handled in the "Closed Area". Unclassified computations are performed in an open area adjacent to the front door. Unclassified drafting and data analysis may also be done in this area.

Immediately behind the "open" Computing Area are the Laboratory and the Counting Room. The Laboratory is to be used for mounting filters in filter holders in preparation for tracer tests and for mounting used filters on slides for microscopic examination. A workbench is provided for performing this work and shelves are provided for storage of materials and supplies. The Counting Room is enclosed to permit microscopic examination of filters under very subdued lighting conditions. So that airborne dust particles can be kept to a minimum, the Counting Room is ventilated by a fan in the ceiling and an air filter in the door. Ap-

II. FIELD OFFICE FACILITIES AND PERSONNEL (Continued)

proximately 26 lineal feet of bench space is available for mounting of microscopes and ultraviolet illuminators; above the benches are shelves for storing filters already examined or to be examined. Additional shelf space is available for storage of UV lamps and other supplies.

Large quantities of meteorological instruments and tracer test equipment must be stored between tests, checked out before tests, and returned to storage after tests. Space for these operations is provided in a cage in the garage. A loading dock between the instrument-storage cage and the alley permits a rapid transfer of equipment to automobiles for use in the field. Maintenance and repair of equipment is also undertaken in the cage.

Because corrosive fumes evolve while batteries are being charged, an enclosed space is provided in a corner of the garage for storing and charging up to 150 batteries to be used in samplers. Two battery chargers of ample capacity with suitable busbars and connectors for rapid and simple attachment to the batteries are located adjacent to the battery storage room. Outside ventilation will keep the concentration of corrosive vapors to a reasonable value.

The remaining garage space is adequate for the storage of a small number of vehicles and for the car-counting of meteorological instruments prior to meteorological surveys.

II. FIELD OFFICE FACILITIES AND PERSONNEL (Continued)

Contamination of the office space, equipment and supplies with fluorescent powder might result in inaccurate data from tracer tests. To minimize this possibility, the fluorescent material and the dispersing units are stored at a location near the University of Minnesota, which is several miles from the field office.

2. St. Louis

St. Louis operations are to be confined to meteorological surveys and tracer tests, and no reduction of data or storage of records is planned for this area. Therefore, the requirements for facilities in St. Louis are limited to a small office and to some garage space where instruments may be mounted on automobiles. Such space, consisting of about 500 square feet was leased at 5589 Pershing, St. Louis, and occupied 3 December 1952. Additional garage space can be obtained for short duration as circumstances warrant.

C. FIELD OFFICE PERSONNEL

As stated previously, the objective of the field office is to plan, prepare for, and conduct field tests, to secure, analyze, and reduce field data, and to perform appropriate administrative duties. As a subordinate yet integral part of the organization, the office must function efficiently with a minimum of supervision while maintaining liaison in the field

II. FIELD OFFICE FACILITIES AND PERSONNEL (Continued)

with other groups participating in the project.

To satisfy such organizational requirements, the Assistant Project Engineer is responsible for all field office operations. His authority and responsibilities include those functions directly related to securing the necessary data and results, maintenance of the field office, compliance with security regulations, maintenance of favorable relations with civic authorities and the general public in areas of field tests and the performance of such administrative duties as are required. Some portions of his responsibilities are delegated to his staff for the purpose of increasing the efficiency of the operation, but the coordination of these activities is a responsibility of the Assistant Project Engineer.

There are two general classes of test data to be obtained from the field operations: first, those data pertaining directly to tracer tests to determine travel and concentration of airborne particles, and, second, those data providing information on mesometeorological conditions which influence the motion of airborne particles. The Chief of Tracer Tests is responsible for data concerning travel and concentration of airborne particles. He plans the tests, supervises the reduction and presentation of data and maintains records pertinent to his operations. He is assisted by a Field Foreman, who supervises the placement and operation of samplers, checks out equipment before tests and checks it in after tests,

II. FIELD OFFICE FACILITIES AND PERSONNEL (Continued)

and delivers to the Chief of Tracer Tests the filters and drum tapes on which the fluorescent particles have been collected. He also submits records necessary to identify the filters and data required for analysis of test results.

Reduction of field test data from tracer tests is done by microscopic examination of the filters under ultraviolet illumination. Two full-time Laboratory Technicians supervise this operation, as well as the preparation of filters for field tests and the maintenance of records. They are responsible to the Chief of Tracer Tests.

Mesometeorological surveys are conducted on a continuing basis to provide information on those factors which influence aerosol travel and diffusion. Detailed meteorological data are also taken at the time and in the immediate vicinity of a tracer test. These surveys are conducted by a group under the direction of the Chief of the Meteorological Division. He is assisted by a Meteorologist who assists in analysis of the data, in interpretation of results and in presentation of the results in usable form. A Field Foreman assigned to this group supervises the work of the meteorological survey crews, who obtain the basic field data from which the results are calculated and analyzed.

The computation of results from field data is supervised by the Chief

II. FIELD OFFICE FACILITIES AND PERSONNEL (Continued)

Draftsman, whose other duties include preparation of maps and graphs for presentation of the reduced data.

Maintenance, repair, and storage of the equipment used are important items in the operation of the field office. These duties are performed by a full-time Instrument man. He was prepared to some extent for these duties when he assisted in the design and fabrication of many of the instruments he is required to maintain.

Since it is planned that meteorological surveys will be conducted in St. Louis simultaneously with those in Minneapolis, a full-time Field Foreman has been assigned the responsibility for conducting these operations.

In addition to the duties directly concerned with obtaining and reducing data, there are certain administrative functions to be performed. These include the maintenance of personnel and time records, purchase and receipt of materials and supplies, and the hiring and assignment of part-time workers. These duties are performed by a full-time Office Manager. He is assisted by a full-time Stenographer who also does the stenographic work required by the Assistant Project Engineer or his staff.

The thirteen full-time personnel whose duties are described above are currently engaged in their allotted functions. Most of them have

II. FIELD OFFICE FACILITIES AND PERSONNEL (Continued)

received Secret clearance, and such clearance has been requested for the other.

In addition to the full-time personnel, approximately sixty-two part-time personnel in Minneapolis and thirty-two part-time personnel in St. Louis have been hired. They serve as field crews for the meteorological surveys and the tracer tests. They are also used in the laboratory to prepare filters and tapes for use in the field and for microscopic examination. Their duties also include counting of particles and computation of test results. As needed, they also assist in preparation of maps and graphs and in the maintenance and repair of equipment. Since their duties do not require Secret clearance, none has been requested for them. They are being granted Confidential clearance on the basis of U.S. birth and execution of the Security, Espionage and Censorship Acknowledgements.

As of 31 December 1952, full-time personnel in the field office worked a total of 6024 hours, and part-time personnel, 3512 hours. As the field tests increase in scope and magnitude, the time worked by part-time personnel will exceed that of the full-time personnel.

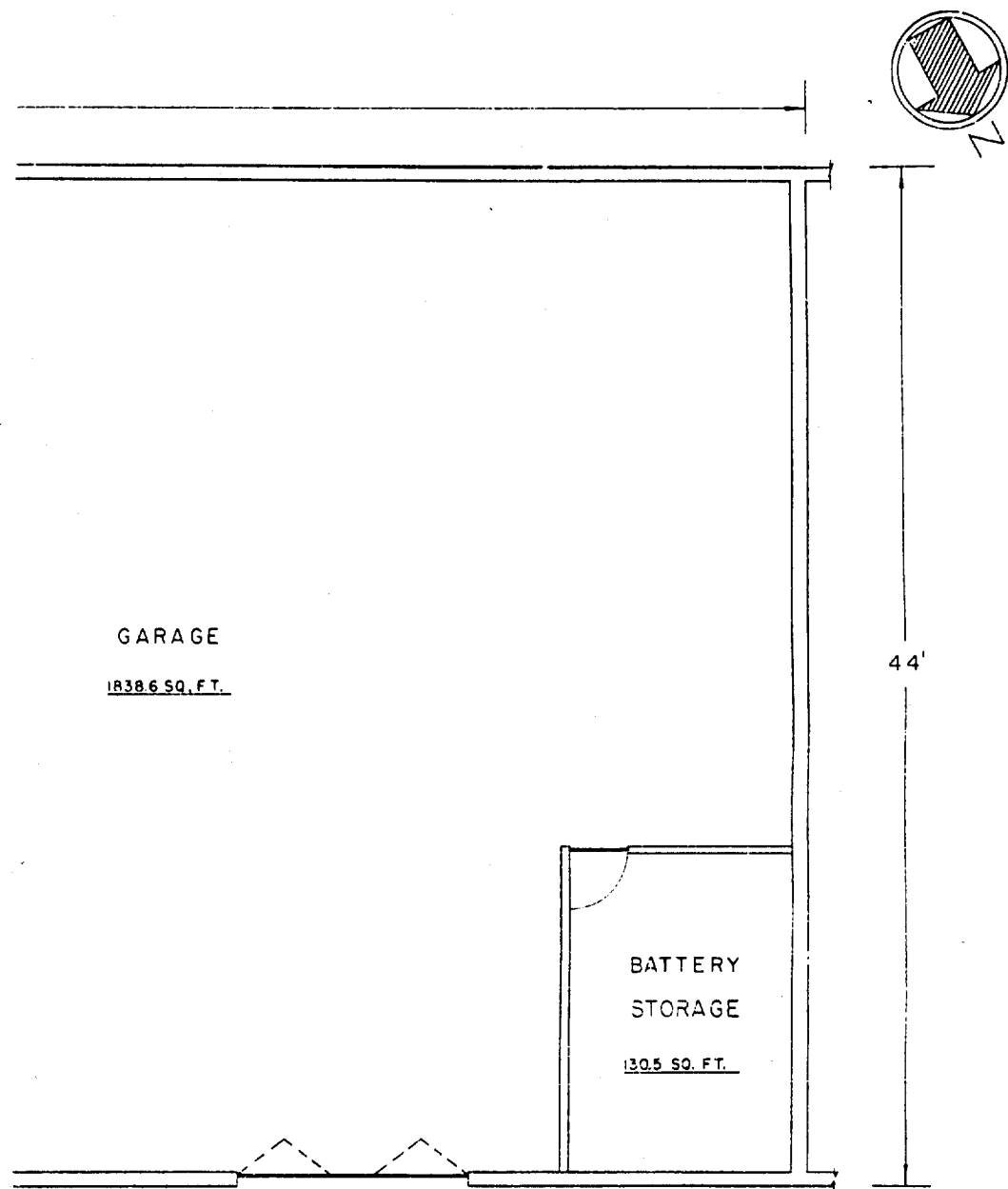

SECRET
SECURITY INFORMATION

FIGURE II-I
MINNEAPOLIS FIELD OFFICE
FLOOR PLAN



400 AVE. SOUTH

SEE MARK

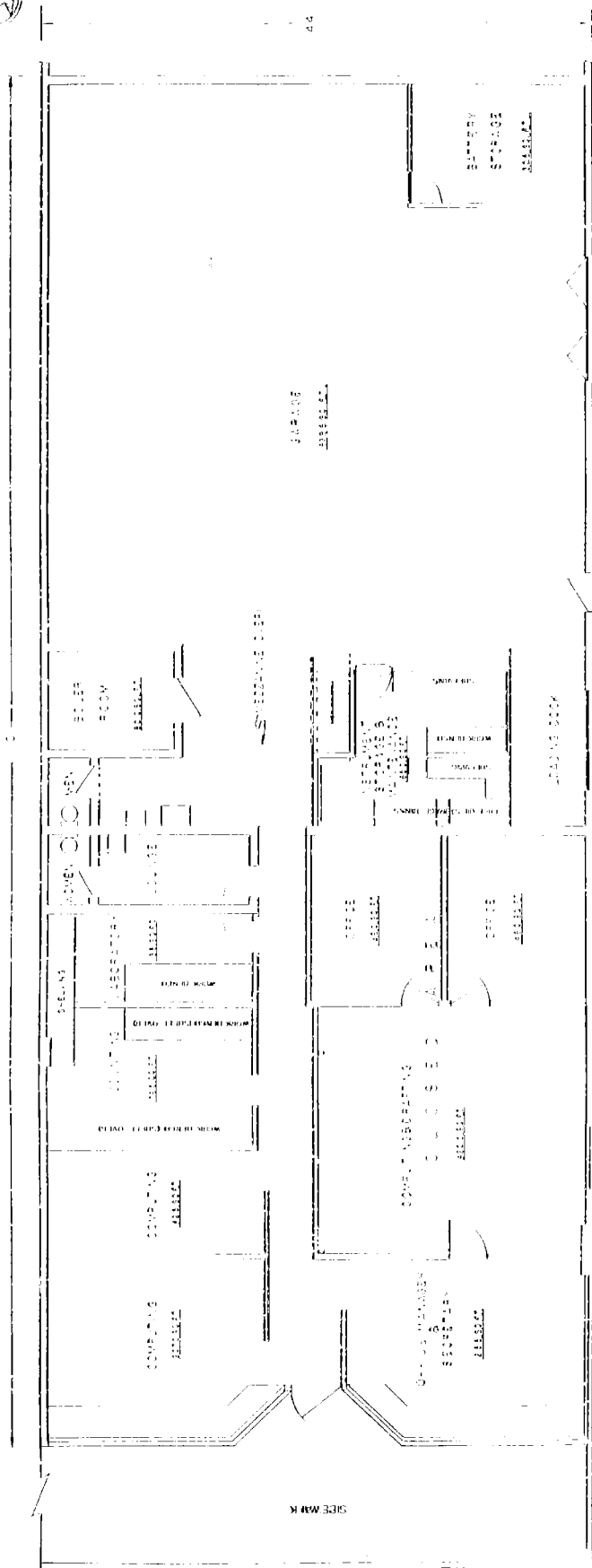

SECRET
SECURITY INFORMATION

FIGURE II-1
MINNEAPOLIS FIELD OFFICE
FLOOR PLAN

III. INSTRUMENTATION

A. PROGRESS

1. General

During the current period, considerable progress was made in the design, production, and use of certain meteorological instruments. Instances of that progress are given in detailed descriptions of the Wind Direction Recorder and the Aspirated Thermistor Air Temperature Indicator, respectively in B and C of the present section.

With the inception of the field test program in Minneapolis and St. Louis, a re-evaluation of the original instrumentation goals has become necessary, applying to both sampling equipment and meteorological instruments. For example, it has been found that more mesometeorological instruments are required than originally estimated. The following factors are responsible for the additional requirements:

- (a) The increased number of traverse routes necessary to provide an adequate density of reading points over the large area, such density to be comparable to that for California cities covered by the Stanford project;
- (b) For a given traverse time the shorter routes per instrument as caused by slow travel in a heavily urbanized district, particularly under adverse weather conditions not normally encountered in California;

III. INSTRUMENTATION (Continued)

- (c) The decrease in allowable out-of-service time per instrument because of the revised plans for additional tests per week.

Such physical factors as the type of paving generally found in the test areas have contributed to further changes. In the case of Minneapolis, where many temperature traverses are made by automobile over rough-surfaced brick or cobblestone streets, the original aspirator design failed to withstand the shocks and therefore has been replaced with a stronger model. The problem of increasing the number of meteorological and sampling instruments, as described below, has thus been complicated in some instances by the need to modify their structural design.

2. Meteorological

In the following table are listed the quantities of instruments originally estimated for the program and the quantities presently required.

<u>Item</u>	<u>Original Estimate</u>	<u>Present Estimate</u>
Portable Wind Direction Recorders	5	5
Aspirated Thermistor Air Temperature Indicators	6	16
Bead-type Thermistor Wiresonde Temperature Equipment	4	4
Wind Velocity Measurement Devices	5	10
Surface Temperature Devices	2	2
Relative Humidity Devices	5	5
Portable Wind Velocity Recorders	1	4

III. INSTRUMENTATION (Continued)

All of the instruments listed above were delivered to the field on 1 January 1953 except for six of the aspirated thermistor air temperature indicators, the four wiresonde bridges, and the wind-velocity recorders. As of 1 January 1953, these bridges were almost 75 per cent complete and are scheduled for completion on or before 1 February, as are the six additional aspirated thermistor air temperature indicators. The only item yet to be developed is the permanent wind-velocity recording unit. A prototype, utilizing a single Esterline-Angus instrument to record both wind direction and wind velocity, has been completed by the Stanford project; if it proves satisfactory in field tests, several models will be built for use in Minneapolis and St. Louis. The thermal anemometer type of equipment mentioned in Joint Quarterly Report No. 1 has been received and tested by personnel at Stanford University; though satisfactory for certain specialized meteorological work, it has not been considered a necessary tool for the contemplated mesometeorological surveys.

3. Sampling and Analytical

Listed below are the items required in the sampling and analytical phase of the instrumentation program.

III. INSTRUMENTATION (Continued)

<u>Sampling</u>	<u>Present Estimate</u>
Membrane Filter Samplers	150
Filter Holders	600
Drum Sampling Units	25
Dispersion Units with Automatic Feed Devices	2
<u>Analytical</u>	
Drum Sampler Counting Microscopes	2
Membrane Filter Counting Microscopes	5
Calibrated Eyepieces	17
UV Illuminators	14
Maintenance Items e.g. Battery Chargers	

As in the case of the meteorological equipment, further familiarity with the test program has dictated some increase in the required quantities of sampling equipment. The membrane filter samplers, for example, have been increased from 75 to 150, including 25 additional sampling units to be used as basic pumping units for the 25 drum-sampling units. In each of the membrane filter samplers four of the magnetic-type filter holders have been included as an integral part. The production and delivery of equipment are nearly complete. All

III. INSTRUMENTATION (Continued)

filter samplers have been shipped to the test sites. Shipment of the first drum-sampling units is scheduled on or about 15 February 1953, the remaining 24 units to be completed within 30 days of that time. The first dispersal unit is now completed, and the second is scheduled for completion by 1 March. All accessory devices and analytical equipment required for the sampling program have been delivered to Minneapolis except for the two special drum-sampler counting microscopes, which will be delivered with the drum samplers themselves.

Because no full-scale tracer tests were completed during the current period, little information is available on the performance of the sampling equipment. Preliminary field tests have indicated that the equipment will perform according to specification and will therefore require no substantial modifications.

B. PORTABLE WIND DIRECTION RECORDER

1. Requirements and Features

In the present test program, representative wind directions are required at many points in the area under examination. It would not be practical to establish 24-hour recording stations at all these points, for in many cases records lasting from 15 minutes to several hours will furnish the required data. When records from any single point might be influenced by highly localized positions, it is desirable to move the

III. INSTRUMENTATION (Continued)

wind direction station quickly from place to place, and thus obtain a better sampling of the general tendency of the wind over a given area.

The resulting data can be used before a test to select the most favorable array for the disperser and sampler locations, to determine the relationship between the local air currents and the records from permanent wind direction stations, to study the effect of temperature distribution on local air drifts, and to aid the interpretation of the sampling results. Instantaneous observations of wind direction, especially at low wind speeds, are of limited value in accomplishing the above purposes. The wind direction changes back and forth continually and may also show progressive drift which will render difficult the comparison of later observations with earlier ones in the determination of local effects.

The desired accuracy in measuring wind azimuth is on the order of $\pm 3^\circ$, since the rate of spread of a cloud with downwind travel may be as little as 15° . This requirement may be impractical to meet on account of the variability of wind direction with time and place, but the instrumental accuracy should not be the limiting factor, and a figure of $\pm 3^\circ$ is therefore set as the desired instrumental accuracy.

In view of the above discussion, the required facilities for measuring wind direction include four portable continuously recording wind direction

III. INSTRUMENTATION (Continued)

units, provided with light and responsive wind vanes capable of being mounted either on top of a car or on a light, quickly set up mast. The major sections of each wind direction recorder, as described below, are: the Wind Vane Unit, the Conversion Unit, and an Esterline-Angus Model AW Graphic Recording Milliammeter, range 0-1 milliamperes. These three units are shown in Figure III-1, and the installation of the unit in a car is shown in Figure III-2.

2. Wind Vane Unit

From the semi-schematic diagram of the electrical circuit (Fig. III-3), it is seen that the azimuth of the wind determines the position of the rotating contact of a 360° (normal) continuously rotatable potentiometer, and that the voltage between one of the fixed ends of the potentiometer winding and the rotating contact deflects the recording milliammeter by an amount which should be proportional to the angular position of the slides.

The wind vane consists of a light balsa-wood air foil 3 inches by 5 inches, firmly attached to a 12-inch length of 1/8-inch aluminum tubing fitted with a counterweight and attached at the balance-point to a crosspiece mounted on a 1/8-inch vertical steel shaft. This shaft rotates in two precision ball bearings held in the wind vane column and coupled to the potentiometer shaft.

III. INSTRUMENTATION (Continued)

The potentiometer is a 250 ohm Microtorque Type 9 (G. M. Giannini Co., Pasadena, California), which is fitted with jeweled bearings and has the precision resistance windings and the rotating contact constructed of platinum alloy wire. By this arrangement, an accuracy of $\pm 0.5\%$ or better is obtained with only .006 inch-ounces of torque required for turning the shaft. When the sliding contact passes across the fixed ends of the potentiometer windings (A in Fig. III-3), a heavy circuit current might flow, ruining the contact, unless a small gap were left in the windings. This gap, amounting to 6° or less, leaves a corresponding "dead space" in the potentiometer indication, but since this can be distributed on either side of the true zero position, the error at the extreme positions is only $\pm 3\%$, and not serious.

3. Conversion Unit

The Conversion Unit furnishes a 0-1 milliamperes current to the recording meter in response to the position of the rotating contact. It contains a 4-1/2 volt battery (Burgess No. 2370 or equivalent), a voltage sensitivity adjusting rheostat (R_2 of Fig. III-3), the proper control switches, and the keep-alive. The function of the latter is to impress a small symmetrical 5-cycle alternating current across the terminals of the E-A recording meter as an addition to the potentiometer signal. This impressed alternating current does not affect the true reading of the

III. INSTRUMENTATION (Continued)

meter, but merely serves to give the pen a slight oscillating motion which reduces the effects of pen-friction and thus causes the pen trace to follow more faithfully the variations in wind azimuth. The keep-alive is indicated in Figure III-3 only as a block, since the circuit details are not directly concerned with the main recording process.

The full 360° azimuth range of the wind vane is made to correspond exactly to a full-scale deflection of the meter by the adjustment of the potentiometer current to such a value that when the rotating contact is at the extreme upper end of the potentiometer lead (marked C in Fig. III-3), the meter reads full-scale. This correspondence is accomplished, without the necessity of rotating the wind vane, by turning Sw_2 to the adjust position and then adjusting R_3 so that the meter reads full scale. When this adjustment has been made, each possible position of the pen trace corresponds to one orientation of the wind vane, except that as the potentiometer contact passes across the gap between the ends of the resistance windings, the pen trace sweeps completely across the chart.

As seen from the illustration of a typical record chart (Fig. III-4), if the operator selects North to be represented by a line in the center of the chart, the two extreme edges of the chart must both be labeled South, with West and East represented respectively by quarter-scale and three-

III. INSTRUMENTATION (Continued)

quarter scale positions. In this case South, the orientation of the wind vane when the potentiometer contact moves across the gap, is referred to as the "anomalous position".

When the wind direction varies rapidly across the anomalous position, the meter pen sweeps continually back and forth across the chart, yielding a record which is difficult to read. Therefore, it is customary to select an orientation of the wind-vane potentiometer housing which will cause the anomalous position to correspond to the least likely wind direction.

The voltage of battery B varies from 4.68 volts for a new battery to about 3.3 volts when the battery is no longer serviceable. The current drain comprises one milliampere for the keep-alive and an average of 16 milliamperes for the wind-vane potentiometer. Assuming the nominal life of four ampere hours for the battery, we may expect a useful life of about 200 hours. At ambient temperatures below 25°F, the battery voltage will drop below a usable value before its rated ampere-hour life is exhausted. In practice, the full-scale adjustment by means of Sw₂ and R₃ must be made often enough to compensate for the gradual decrease and recovery in battery voltage as the equipment is switched on and off (Sw₁).

III. INSTRUMENTATION (Continued)

Although a greater battery capacity would reduce the amount of attention required to insure full-scale adjustment at all times, the battery employed in the Control Unit allows this unit to be made small enough to be bolted directly on the side of the E-A meter, and the number of components to be carried separately is thus reduced. A pair of leads connects the Control Unit to the meter terminals, and a 15-foot three-wire insulated cable, fitted with plugs at both ends, connects the Wind Vane Unit to the Control Unit.

4. Recording Milliammeter Unit

The function of the spring-wound Esterline-Angus 0-1 milliampere recording meter has already been described in the previous sections. The inked pen travels across a 4-1/2 inch chart which can be driven at governor-controlled speeds of 3/4, 1-1/2, 3, or 6 inches per minute (with 3 hours' running time without rewinding) or at clockwork-controlled speeds of 3/4, 1-1/2, 3, 6, or 12 inches per hour (8 days' running time).

In the circuit under discussion, the response time of the heavily built D'Arsonval meter movement, which drives the pen, is on the order of 1-1/2 seconds for a 99% complete response and the pen does not overshoot. This speed of response is sufficiently fast to enable a qualitative visual estimate of the steadiness of the wind and of the short-period extremes in the variation of wind direction during the recording period.

III. INSTRUMENTATION (Continued)

In addition to the recording pen, each instrument is equipped with two chronograph pens writing in the margin on either side of the chart-space. These pens leave a straight ink line except when the pen-solenoids are energized electrically (6V at 0.25A); the line is then displaced 1/5 inch toward the edge. In this way it is possible to record timing calibrations or other time phenomena in synchronism with the main record. At present it is planned to utilize these pens to register electrical pulses from a 3-cup anemometer, and thereby to record on one meter both wind speed and wind direction.

5. Calibration and Accuracy

A direct measurement of the electrical accuracy of the system described was made by fitting a number of wind-vane potentiometers with a pointer and mounting them in the exact center of a 360° protractor. The meter indication was then followed as a function of the orientation of the potentiometer shaft. Figure III-5 shows the error curve thus obtained, i.e., the difference between the indicated angle and the true angle. This curve was obtained with the meter sensitivity properly adjusted by means of Sw_2 and R_3 ; the angles were read off with respect to the protractor setting which produced a reading at center of the chart scale. This setting is called the "reference setting", and is approximately 180° from the anomalous position.

III. INSTRUMENTATION (Continued)

The reference setting will not correspond to the exact electrical center of the resistance winding because the meter draws a current which is an appreciable fraction of the potentiometer current. With the values given, it is calculated that the potentiometer will be set at 185° rotation instead of 180° ; at meter readings greater or less than the center position, this disparity will be reduced, becoming zero at either extreme setting. The maximum error found in the direct calibration by means of the protractor is less than 3° , thus indicating that the 5° discrepancy calculated above is partially compensated by the 6° gap in the potentiometer winding.

A 60-division chart paper is used, which can easily be read to the nearest $1/2$ division or 3° azimuth. This reading would be a little more exact than the rated minimum accuracy of the meter (given as $\pm 1\%$ by the manufacturer), but tests show that the accuracy of the meters when they are used with a keep-alive tends more nearly to correspond to $1/4$ rather than $1/2$ chart division.

In addition to errors produced by electrical inaccuracies, there will be mainly those produced by (a) the orientation of the potentiometer housing and (b) the lack of parallelism between the wind vane axis and the true wind direction.

III. INSTRUMENTATION (Continued)

The error produced by (a) occurs in the process of setting up the wind-direction equipment at a new location. In normal procedure, after the vane-mounting rod has been loosely clamped in its holder, the wind vane is turned relative to the potentiometer housing until the meter indicates half-scale; this position, designated above as the reference setting, can be indicated by vertical scratches on the fixed wind-vane column and on the rotating dust cover attached to the crosspiece. While the wind vane is kept at the reference setting, the entire wind vane unit is rotating in the holder by which it is fastened until the vane points in the direction chosen to be represented by the reference setting, and the clamp is then tightened. The error introduced by this procedure will be determined by the accuracy with which the wind vane can be sighted on a reference point having the desired azimuth, and, of course, will include the uncertainty in determining that azimuth. If a compass is employed, errors may be caused by stray magnetic fields such as those next to steel car-bodies, near direct-current streetcar lines, or in the vicinity of steel buildings.

With care, it is possible to orient the wind vane to the nearest degree, and an accuracy of $\pm 5^\circ$ should be easy to obtain even when time is short.

The error (b), arising from lack of parallelism between the wind vane

III. INSTRUMENTATION (Continued)

axis and the true wind direction, is more difficult to evaluate. No direct tests, such as wind-tunnel tests, have been made. A lack of bilateral symmetry in the hand-made wind vanes could conceivably produce an error of several degrees, and if the wind vane is mounted on a parked car the local turbulence and distorted streamlines will undoubtedly have an effect, as will the canting of the car when not parked on level ground.

The total effect of all the various errors encountered in the field use of the Wind Direction Recorder is difficult to estimate, since it depends so much on the particular circumstances. It is probable that under the best conditions the maximum error will amount to some $\pm 3^\circ$ and that equipment when used on routine operations in cities will indicate the mean air-drift in the vicinity of the wind vane within $\pm 10^\circ$.

6. Field Performance

To date no adverse comments on the field performance of the Wind Direction Recorder have been received. Several units, each with its shock-mounted recording meter attached to the floor of the car, have been operated at outdoor temperatures down to -10°F . The reference setting of the wind vanes was oriented along the axis of the car, and the latter was parked parallel to north-south or east-west running streets.

III. INSTRUMENTATION (Continued)

This procedure enabled rapid coverage of a succession of locations in the area under examination and has yielded useful data of the required type. Thus, the equipment described above has met the requirements of the present field test program.

C. ASPIRATED THERMISTOR AIR TEMPERATURE INDICATOR

1. Requirements and Features

The aspirated air-temperature thermistor is intended chiefly as a means of obtaining the air-temperature distribution pattern over areas as large as several square miles. Since the air temperature is constantly changing with time and can usually be expected to vary locally from the mean horizontal trend, the equipment must enable a rapid coverage of a large number of points. When the temperature distribution over a large city is to be studied, it has been found most efficient to have a number of automobiles operating at once over predetermined routes, so that the data for the entire isotherm map can be taken over the course of an hour or so.

The above requirements suggest that the air-temperature sensing element employed should have a rapid response, that it should indicate by a direct deflection method rather than by the slower null-adjustment method, and that the indicating element should be capable of being read

III. INSTRUMENTATION (Continued)

while the vehicle containing the equipment is in motion at normal road speeds. Moreover, since a number of instruments are to be simultaneously employed, the cost of each should not be excessive, the installation of the equipment in an ordinary passenger car should not exclude that vehicle from its normal use, and the data resulting from these temperature traverses should not require excessive treatment before they can be presented in their final form.

Instruments closely fulfilling the above requirements have been previously used at Stanford University (SQM 450-6). These employed the Western Electric 14-B thermistor as the temperature-sensing element, connected to a Wheatstone bridge with a Weston Model 301 0-50 microammeter as the unbalance indicator. This indicating meter was selected as the most sensitive meter that should be employed in this type of service, since a more sensitive one would be vulnerable to mechanical shocks and would require a steadier reading platform than that furnished by a moving car. Two conclusions may be drawn from the extensive use which Stanford personnel have made of thermistor temperature elements for over a year:

- (1) the operation of these elements with their associated equipment in reliable car-mounted measuring equipment is amply justified;
- (2) other temperature-sensing elements such as wire-wound resistance thermometers, thermocouples, bimetal thermometers, and liquid-expansion thermometers

III. INSTRUMENTATION (Continued)

do not appear to offer the same advantages.

The bridges described below were designed to cover a wider span of air temperatures than the span considered sufficient for use near Stanford. The extended span consists of eight ranges: -40° to -15°F , -20° to 5°F , 0° to 25° , 10° to 35° , 30° to 55° , 50° to 75° , 70° to 95° , and 90° to 115°F . The temperature coefficient of the 14-B thermistor resistance is such that with two thermistors connected in parallel and with the bridge current kept low enough to prevent an excessive I^2R temperature rise of the thermistor elements, a 1°F change in air temperature can be made to produce a 2 microampere change in the bridge-imbalance meter reading. This sensitivity allows the desired 25°F coverage for each range.

The physical appearance of the 14-B thermistors may be inferred from Figure III-6, which shows a matched pair with the leads connected in parallel to the insulated flexible pigtails and held in a $5/8$ inch diameter lucite cylinder filled with insulating water-proof potting compound. The sensitive portion of each thermistor consists of a $1/16$ inch diameter globule of semi-conductor, a mixture of heavy metallic oxides, into which are fused two fine platinum wires which in turn are welded to somewhat heavier glass-sealing alloy wires. The globules and leads are fused into a glass tube about $2\ 1/2$ inches long,

III. INSTRUMENTATION (Continued)

with the uninsulated leads extending another 2 1/2 inches for making connections.

After potting, the thermistor-pair temperature element is moisture-proof and has a resistance of about 1000 ohms at 70°F and 10,000 ohms at 0°F. The response to rapid temperature changes is much faster than that of a mercury thermometer by virtue of the smaller mass and diameter of the sensitive portion of the thermistors. To increase the speed of response, and to protect the black thermistor globules from gain of heat by solar radiation or loss of heat by radiation to the cold night sky, the temperature elements are installed in double walled nicked brass tubes, through which a proper rate of aspiration is maintained.

2. Bridge Circuit

Although the resistance of the thermistor temperature element is far from a linear function of temperature, it has been possible to select such values for the resistors R_A , R_B , R_C , R_X , R_Y , and R_S in the simplified bridge circuit shown in Figure III-7 that at a specific temperature M_1 reads zero microamperes, M_1 reads exactly 50 microamperes at a temperature 25.0°F above this specified temperature, and over the middle ranges of outdoor temperatures, intermediate meter readings correspond point for point within $\pm 0.2^\circ\text{F}$ to the intermediate temperatures.

III. INSTRUMENTATION (Continued)

The purpose of R_p , R_z , and $M2$ is to insure that the current through R_x and the rest of the bridge may be kept constant despite gradual changes in the voltage of battery B, which would of course affect the indication (other than zero) of $M1$. This current constancy is maintained by adjustment of the rheostat R_{adj} so that $M2$ always shows a chosen constant deflection, usually 45 microamperes. R_z is selected so that $M1$ and $M2$, at about 70°F air and instrument temperature, are fed through similar network resistances and some measure of temperature compensation is thus obtained; that is, if the bridge is calibrated at room temperature by immersing the thermistors in a water bath, this calibration will tend to be valid at other instrument temperatures by virtue of the fact that any temperature change affecting $M1$ will in nearly like manner also affect $M2$. For example, if the sensitivity of $M2$ decreases slightly, a higher bridge current will be required to produce the standard deflection on $M2$, and this higher bridge current will just compensate for the concomitant decrease in sensitivity of $M1$. In many instances, of course, the instrument temperature will be nearer to the outdoor air temperature which is being measured than it will be to the laboratory temperature at which it was calibrated.

The actual bridge circuit, shown in schematic form in Figure III-8, differs from the simplified circuit in that the switching system pro-

III. INSTRUMENTATION (Continued)

vides for eight 25°F ranges, covering the entire interval from -40°F to 115°F with overlaps of 5°F or more. Also, a single 0-50 micro-ampere meter is used for both M1 and M2, this meter being readily switched from one circuit to the other. Provision is also made for short-circuiting the meter when the battery switch is in the "off" position, thus retarding the swing of the moving coil and pointer and thereby reducing unnecessary wear on the meter pivots when the instrument is carried about.

The complete assembly of bridge components, including the meter, is mounted in a metal box which is fastened to a clipboard that can be conveniently held in the lap, and provision is made for illuminating both the meter and the data sheets when the bridge is used at night. The two-conductor line which connects the bridge to the thermistor temperature element, for which purpose a two-prong plug and an equivalent pair of binding posts are provided, should be less than 1 ohm in resistance and should have a leakage resistance of more than 20 megohms if the accuracy of the measurement is not to be impaired.

3. Automobile Thermistor Mounting

The thermistor temperature-sensing element is mounted about five feet above the trailer hitch which is secured to the front bumper (Fig. III-9). The temperature of the oncoming air which is drawn through

III. INSTRUMENTATION (Continued)

the aspirated housing is thus least affected by the forward-moving car. The rate of aspiration past the thermistors is always at least 8 mph, and because of the resistance of the blower squirrel-cage this rate does not increase proportionately to the forward speed of the car. Therefore, cars travelling on the same route at different speeds, or even when parked, will still obtain comparable temperature records, as long as the tassel attached to the aspirator head indicates that the wind is blowing toward the radiator.

The thermistor element is set far enough back in the protective tube so that only at sunset or sunrise will the sensitive portion be heated directly by the sun's rays, and then only by heating within 15° azimuth of the sun's position. The protected position of the thermistor element also reduces the chance that water splashes, insects, or gravel will strike the thermistors.

4. Aircraft Thermistor Mounting

The self-aspirated aircraft thermistor mounting, illustrated in Figure III-10, shields the thermistor against most radiation effects, affords some mechanical protection, and forms a safe and rugged attachment to the plane. A twin-conductor lead connects the thermistor element, which is similar to that used in the automobile thermistor mounting, to the bridge and clipboard unit held in the observer's lap. The observer

III. INSTRUMENTATION (Continued)

must also be able to record the altitude, position, and time at which the temperature observation is made.

The most satisfactory point of attachment varies with type of plane. The mounting may be bolted to two padded pieces of plywood between which two wing struts, a vertical and a diagonal, are clamped; alternatively it may be attached to a padded base board which is bolted to the roof of a cabin type of plane. In any case, the head of the mounting should be oriented parallel to the slip stream, there should be no source of heated air ahead of the element, the mounting should offer as little air-resistance as possible, and utmost safety precautions must be observed to insure that the mounting is secure and that the plane is not structurally weakened.

When a simple temperature-sensing element, such as a thermistor or thermometer, is held in a stream of moving air, the equilibrium temperature attained by the element will always be higher than the true air temperature. The necessary correction, which must be subtracted from the indicated temperature, is a function of the size and shape of the sensing element, but depends mainly on the compression heating of the air as it is brought to a standstill in the thin film of stagnant air immediately surrounding the element. This heating varies as the square of the air speed, and amounts in the ideal case to 1.8°F at 100 mph, 1.4°C at 90 mph,

III. INSTRUMENTATION (Continued)

and 4°F at 150 mph. In practice, it is found that about 60% of the above figures at all plane altitudes is more nearly right, partly because there is a backflow of heat by molecular conduction across the stagnant layer to the cooler moving air.

For the purposes of the contemplated aircraft temperature surveys, where relative air temperature is more important than absolute air temperature, it is considered satisfactory to maintain the plane speed at 100 ± 5 mph, and to apply a correction of -1.2°F to the indicated temperature. This correction introduces an additional uncertainty of perhaps $\pm 0.5^{\circ}\text{F}$ in the absolute accuracy of the temperature records over and above the uncertainty inherent in the thermistor and bridge combination, which is of the order of $\pm 0.3^{\circ}\text{F}$. This total uncertainty is small enough to allow good significance in the extension of ground and wire-sonde temperature profiles up to aircraft altitudes.

5. Calibration and Accuracy

One of the greatest disadvantages of the use of thermistors as temperature elements lies in the fact that each individual thermistor taken from a group received from the manufacturer will have a different set of temperature-resistance characteristics. Except for a small percentage of units, however, these characteristics are repeatable to better than $\pm 0.1^{\circ}\text{F}$ after following the manufacturer's recommendation that the

III. INSTRUMENTATION (Continued)

thermistor be annealed for 24 hours at a constant temperature somewhat higher than the maximum temperature to which they will be subsequently exposed, and provided that the glass enclosing the leads has not been cracked. The admittance of even small amounts of moisture into a cracked seal will cause an erratic shunting effect on the total resistance. At low temperatures when the resistance is high, this shunting effect will render the thermistors unreliable.

When the temperature-resistance characteristics are plotted on a graph in which the ordinates are laid off in terms of $\log_{10} R$ and the abscissae in terms of $\frac{10^4}{-OR}$ (where OR is the absolute temperature in degrees Fahrenheit), the entire resistance function between $-40^\circ F$ and $+120^\circ F$ approximates closely a straight line, and can be represented with a precision of $\pm 0.1^\circ F$ over the whole curve from $-40^\circ F$ to $+120^\circ F$ by straight lines drawn between five calibration points spaced about $30^\circ F$ apart. The individual thermistor curves usually lie nearly parallel to each other, and are displaced over a range of $\pm 3^\circ F$ for equal resistances.

From the above set of calibration curves for a large group of thermistors, a design mean curve may be drawn, centered so that equal numbers of thermistors with approximately uniform slopes are above and below the design mean. This curve is used to calculate the values of the bridge resistors required to make the scale as direct-reading as

III. INSTRUMENTATION (Continued)

possible (starting from an even temperature and covering exactly 25°F for each range), and these resistors, specified to 1/10% accuracy, are ordered specially wound with low-temperature-coefficient resistance wire. Since the temperature coefficient of the thermistor resistance is about 2.8% per °F, a maintained precision of 1/10% in the measurements and specifications corresponds to a precision of about 1/20°F in the individual steps of the calibration procedure.

The thermistor pairs used in the sensing elements are made up from one thermistor above the design mean and the other thermistor an equal amount below if possible. The group of pairs may be further brought towards identical behavior by the addition of small series-trimming resistors and large shunt-trimming resistors as required.

Residual deviations from the design mean curve among the pairs are compensated for in the final correction curve to be applied to the bridge reading. This curve involves corrections seldom exceeding $\pm 0.5^\circ\text{F}$ except at the extreme 25° ranges. This correction curve is obtained by re-calibrating the thermistor pairs at five temperatures, making another log R against $\frac{10^4}{R}$ curve, and tabulating from this the sensing-element resistance at even 5°F temperature steps. These resistance values are then successively set up on a resistance box, applied to the bridge with which it is intended to use the particular thermistor pair, and

III. INSTRUMENTATION (Continued)

the difference taken between the nominal even 5°F temperature and the bridge microammeter indication for that particular range.

The steady temperatures required for the calibration points are obtained in a water bath maintained at 95.0°F ± .05° or 65.0°F ± .05°, an ice-water equilibrium bath effectively at 32.0 ± .05°F, a eutectic ethylene glycol and dry-ice bath at approximately 0°F, and a eutectic tertiary amyl alcohol and dry-ice bath at approximately -20°F. The bath temperature in the immediate vicinity of the thermistors is measured by single copper-constantan thermocouples, using ice as a reference junction and measuring the thermal emf. to the nearest microvolt, which corresponds to a sensitivity of ± 1/20°F.

The thermocouples themselves are calibrated by reference to a Leeds-Northrup No. 8160-A platinum resistance thermometer, maintained by the Stanford University Chemistry Department and furnished with a National Bureau of Standards certificate. High quality mercury-in-glass thermometers are also used as intermediate standards, but are not sufficiently responsive to indicate the small local variations occurring in the below-freezing baths, which are more difficult to maintain at steady equilibrium temperatures.

When the bridge itself is kept at ambient temperatures between 30°F and

III. INSTRUMENTATION (Continued)

100°F, the outside limits of error of the equipment described is estimated to be $\pm .4^\circ$ to $\pm .6^\circ$ F in the measurement of air temperature, of which $\pm .2^\circ$ F may be ascribed to the cumulative errors in calibration, $\pm .2^\circ$ F to possible deviations from linearity in the microammeter scales, and $\pm .2^\circ$ F as the maximum heating of the thermistors in the aspirated air stream by the bridge current; this heating is serious only on the upper two ranges.

At ambient temperatures outside of the range 30° to 100°F, there will be an additional error up to a few tenths of a degree due to changes in the resistance of the copper-wound microammeter coil. This effect is probably not important at sustained temperatures below 20°F, since the dry cells comprising the bridge battery will freeze and become short-lived.

In actual practice, it has been found that several pieces of equipment when placed outdoors side by side usually agree within $\pm 0.1^\circ$ or 0.2° F of the common mean and that they can be read significantly to the nearest tenth degree. This intercomparison of instruments is part of the recommended procedure in the use of the bridges, since it is important that all instruments read alike when several are in use simultaneously during an extended survey. Because the bridges indicate on a nearly linear scale, it is valid to make an additional single-valued correction

III. INSTRUMENTATION (Continued)

to each bridge to bring them to a common reading.

6. Field Performance

In starting out on a temperature survey, the normal procedure is to press the bridge current "adjust" button and set the bridge current by means of the rheostat to the prescribed meter deflection. Releasing the button then causes the microammeter needle to deflect according to temperature, and a proper on-scale position may be obtained by setting the range switch to the proper temperature range. The meter reading, added to the base temperature shown on range switch dial, gives the uncorrected temperature indication. This is recorded along with time and location on the data sheet carried by the clipboard and subsequently corrected. The bridge current is checked occasionally by pressing the adjust button and, if necessary, readjusting the rheostat. Experience soon shows how often this readjustment must be made--more often in cold weather, but normally only every hour or so provided that the batteries are in good condition.

The compactness of the bridge and clipboard unit has proved to be of considerable advantage. Since many of the observations are made at night in moving cars, restricted lighting of the meter and writing pad is highly desirable. The self-contained sources of illumination provided with the bridge-clipboard unit (one 3-volt flashlight bulb over

III. INSTRUMENTATION (Continued)

the meter and one over the writing pad) have not been considered adequate by some observers; in this case, the use of a 6-volt automobile trouble light plugging directly into the cigarette lighter on the dashboard has been found quite satisfactory.

The isotherm maps presented in the Appendix are based on data taken with the car-mounted thermistor bridges. In drawing the 1[°]F interval isotherms from these data, it has been found that relative measurements to $\pm 0.1^{\circ}$ F are worthwhile in that this degree of accuracy is frequently significant in assigning exact positions to these lines. During the traverse of normal routes, the microammeter needles respond mainly to true temperature variations rather than to mechanical vibrations of the car. Normally the observed temperature drift is slow enough so that with a little judgment, representative temperature values to the nearest tenth degree may be assigned to each designated reference point on the map route.

There are, however, many situations where the observed air-temperature variations are of far less representative significance than would be indicated by stating them to the nearest tenth degree. For example, under conditions of strong inversion the passage of other cars on the road may disturb the temperature stratification so that at six feet the air temperature is temporarily affected; at high speeds, the measuring car

III. INSTRUMENTATION (Continued)

itself may lift the air appreciably. Moreover, local sources of warm or cold air, such as small air drainage channels, steam vents, underpasses, irrigated gardens, etc., will produce noticeable effects lasting for several seconds after the car has driven by.

The response time corresponding to a 63% indication of a sudden temperature variation in the air encountered by the aspirated thermistor-sensing element has been determined to be about five seconds. Since a car at 30 mph would traverse 220 feet in this time, it is evident that when steep gradients along the route are encountered, cars going in opposite directions at this speed may not record exactly the same temperature at the same point. Occasionally, then, the response-time must be taken into account, but normally a small amount of time lag serves to average out the more rapid and essentially meaningless fluctuations in air temperature, particularly those encountered under lapse conditions, and thus enables steadier readings to be obtained.

D. PLANS

After 15 February 1953, when production of meteorological and sampling equipment is scheduled for completion, the production phase of the instrumentation program will receive minor attention in future reports. Continuing attention, however, will be given to instrumentation and will be based on (a) field reports on the efficiency and reliability of

III. INSTRUMENTATION (Continued)

instruments, and (b) applicable advances in the field of instrumentation. Necessary modification or replacements will be made to insure successful completion of the test program. As in the past, this continuing phase of the instrumentation program will be the joint responsibility of Stanford University and The Ralph M. Parsons Company.

It is further planned to produce a separate instrumentation manual covering all special equipment designed and produced for this project. This manual, which will be based on more extensive experience in the field and on any desirable modifications in the equipment, will include in detail those purely technical aspects of the instrumental design and performance which are, in the interests of brevity, omitted from the Joint Quarterly Reports.

The instrumentation section of these reports, however, will contain sufficient descriptions of the instruments to familiarize the reader with the equipment and to enable him to judge the significance of the field data presented in other sections. Accordingly, the Portable Wind Direction Recorder and the Aspirated Thermistor Air Temperature Indicator have been considered in this report.

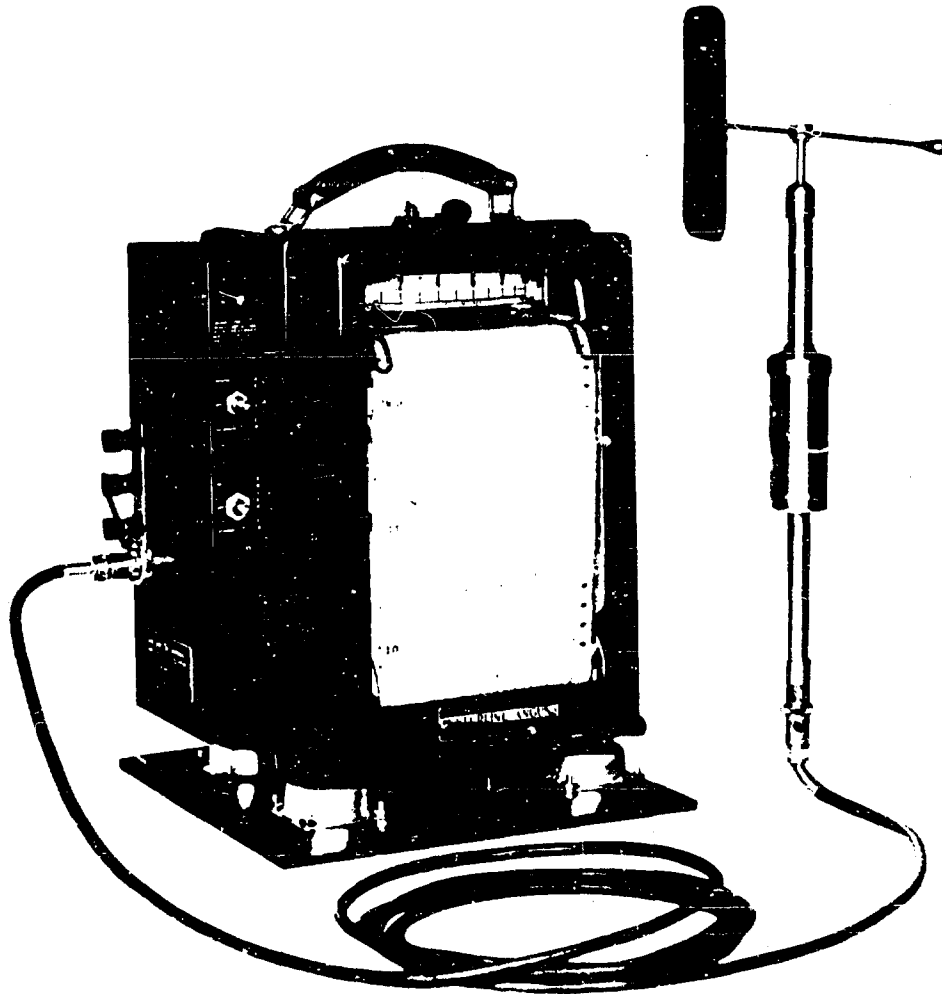

Fig. III-1 Wind Direction Recorder and Wind Vane



Fig. III-2 Wind Vane Installation on Meteorological Survey Car

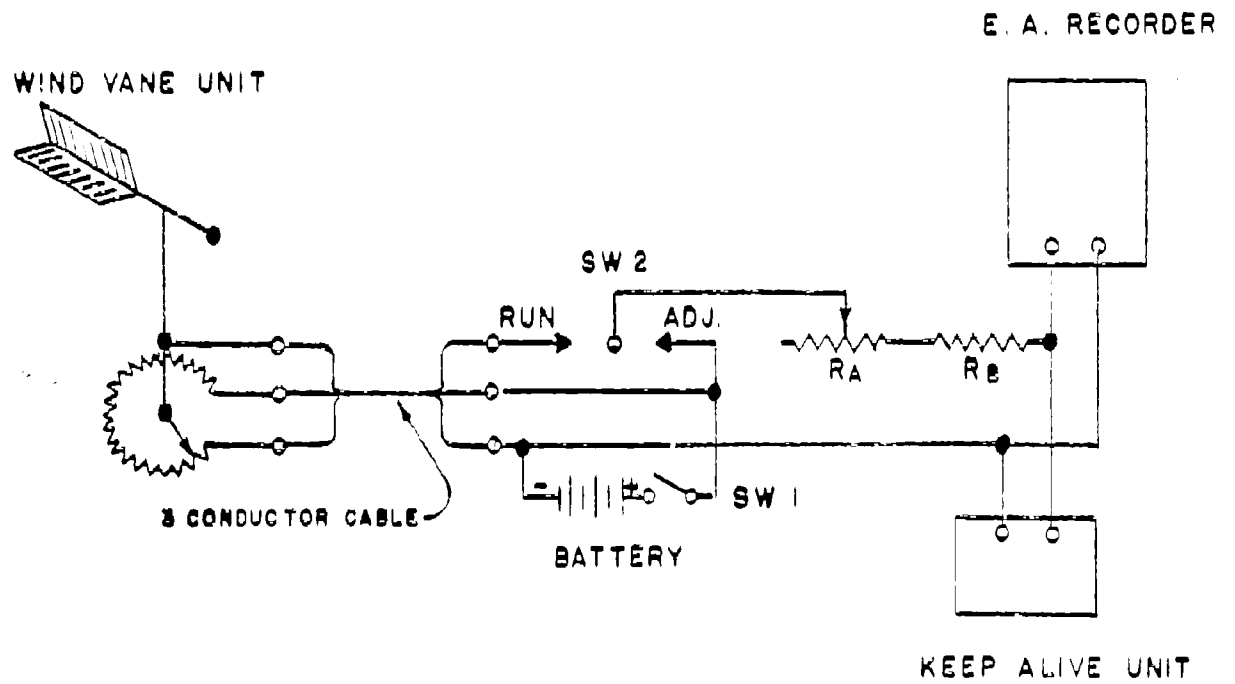

Fig. III-3 Block Diagram of Wind Direction Recorder

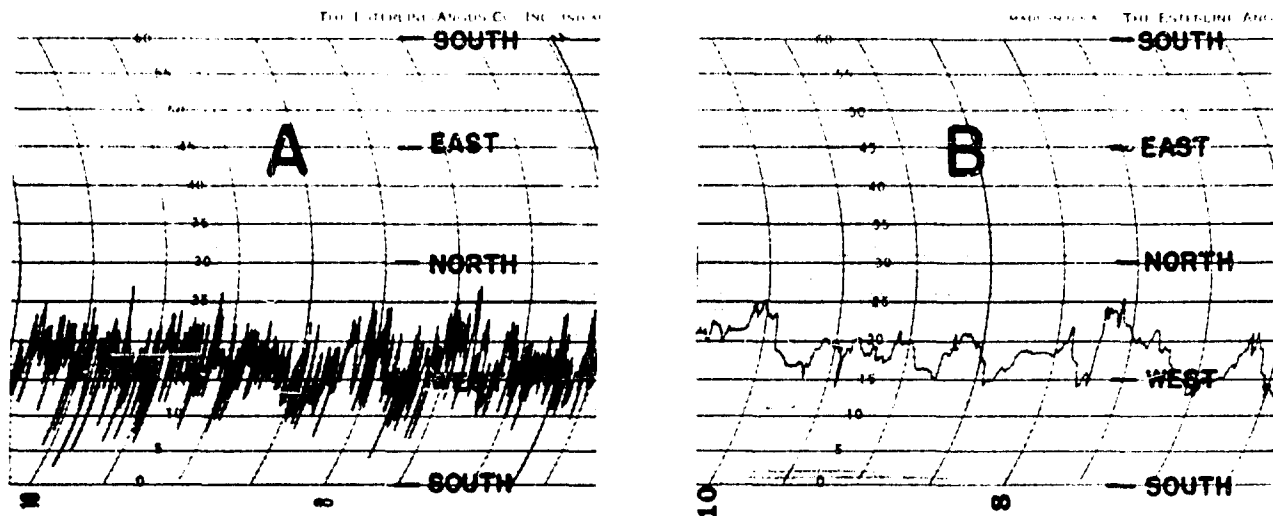

Fig. III-4 Typical Wind Direction Records from Wind Direction Recorder A at 6 inches per hour, and B at $1\frac{1}{2}$ inches per minute Full size width of chart is $4\frac{1}{2}$ inches

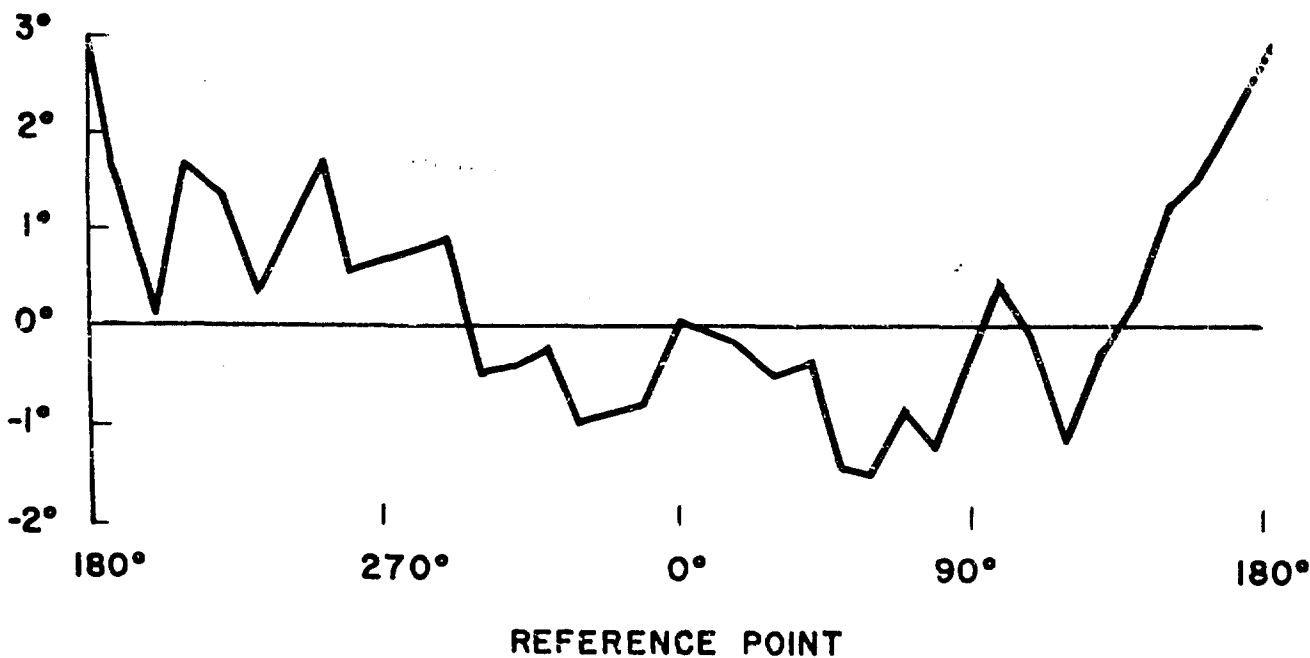

Fig. III-5 Error Curve of Wind Direction Recorder Using Type 9 Microtorque Potentiometer Points are taken at 10° azimuth intervals from reference setting (0°).



Fig. III-6 Parallel Thermistor Temperature Sensing Element

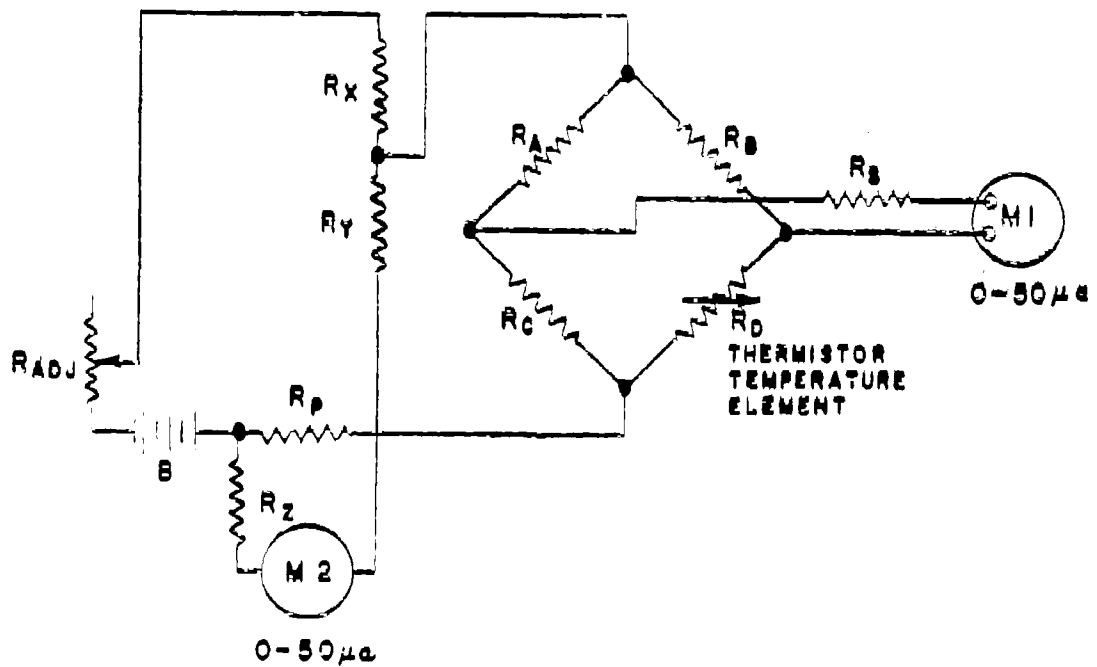
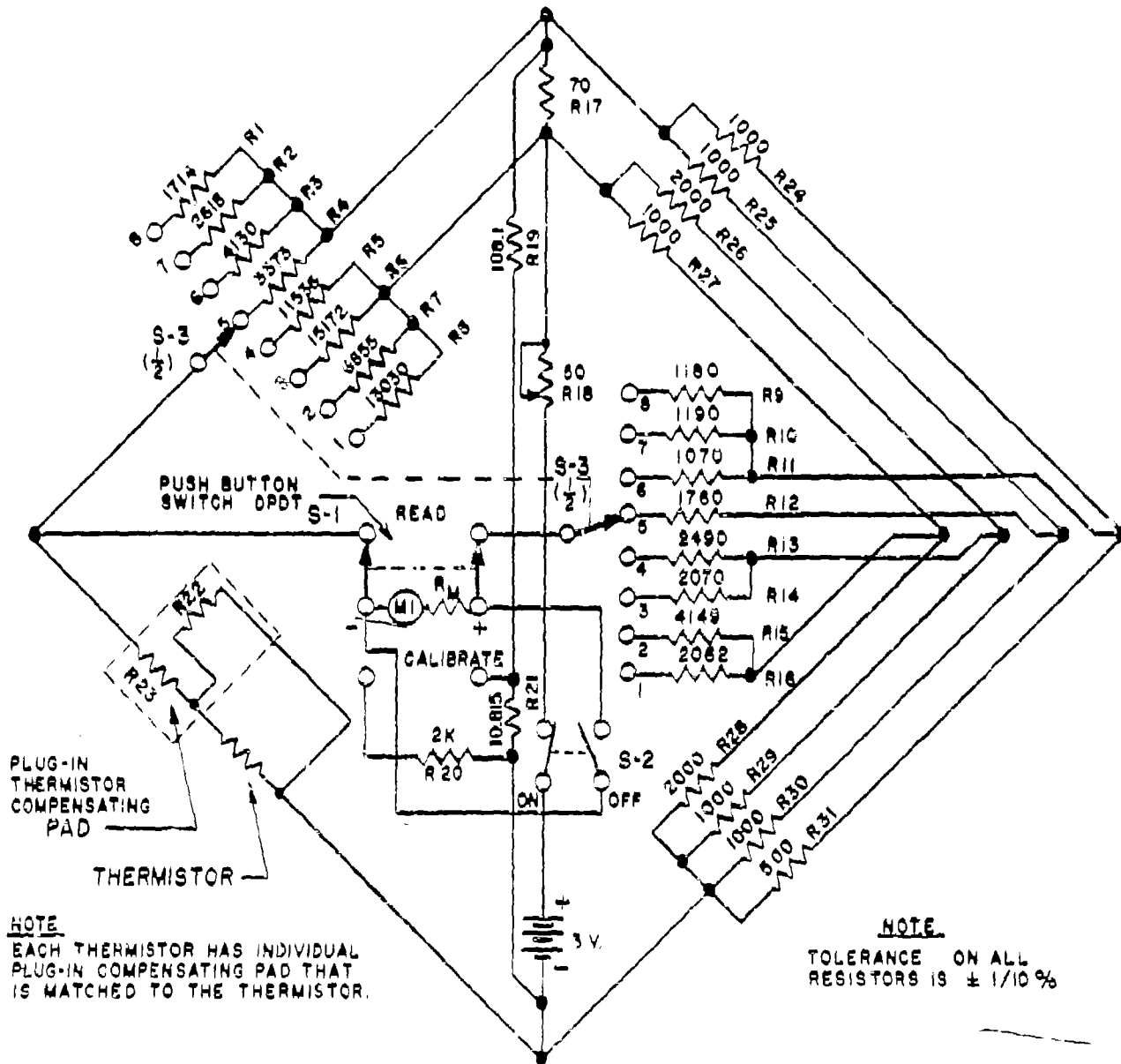

Fig. III-7 Simplified Schematic Diagram of Temperature Indicating Bridge



NOTE
EACH THERMISTOR HAS INDIVIDUAL
PLUG-IN COMPENSATING PAD
THAT IS MATCHED TO THE THERMISTOR.

NOTE
TOLERANCE ON ALL
RESISTORS IS $\pm 1/10\%$

ADJUST METER TO $22\frac{1}{2}^{\circ}$ FOR CALIBRATION

METER HAS PADDING RESISTOR IN SERIES WITH IT, MAKING TOTAL RESISTANCE 1100 OHMS.
METERS VARY FROM 1025 OHMS TO 1125 OHMS. CANNOT USE THOSE OVER 1100 OHMS.

RANGES	
SWITCH POS.	START
1	-40°F
2	-20
3	0
4	10
5	30
6	50
7	70
8	90
MAX. READING $90+25^{\circ}$ $= 115^{\circ}$	

Fig. III-8 Schematic Diagram of
Temperature Indicating Bridge

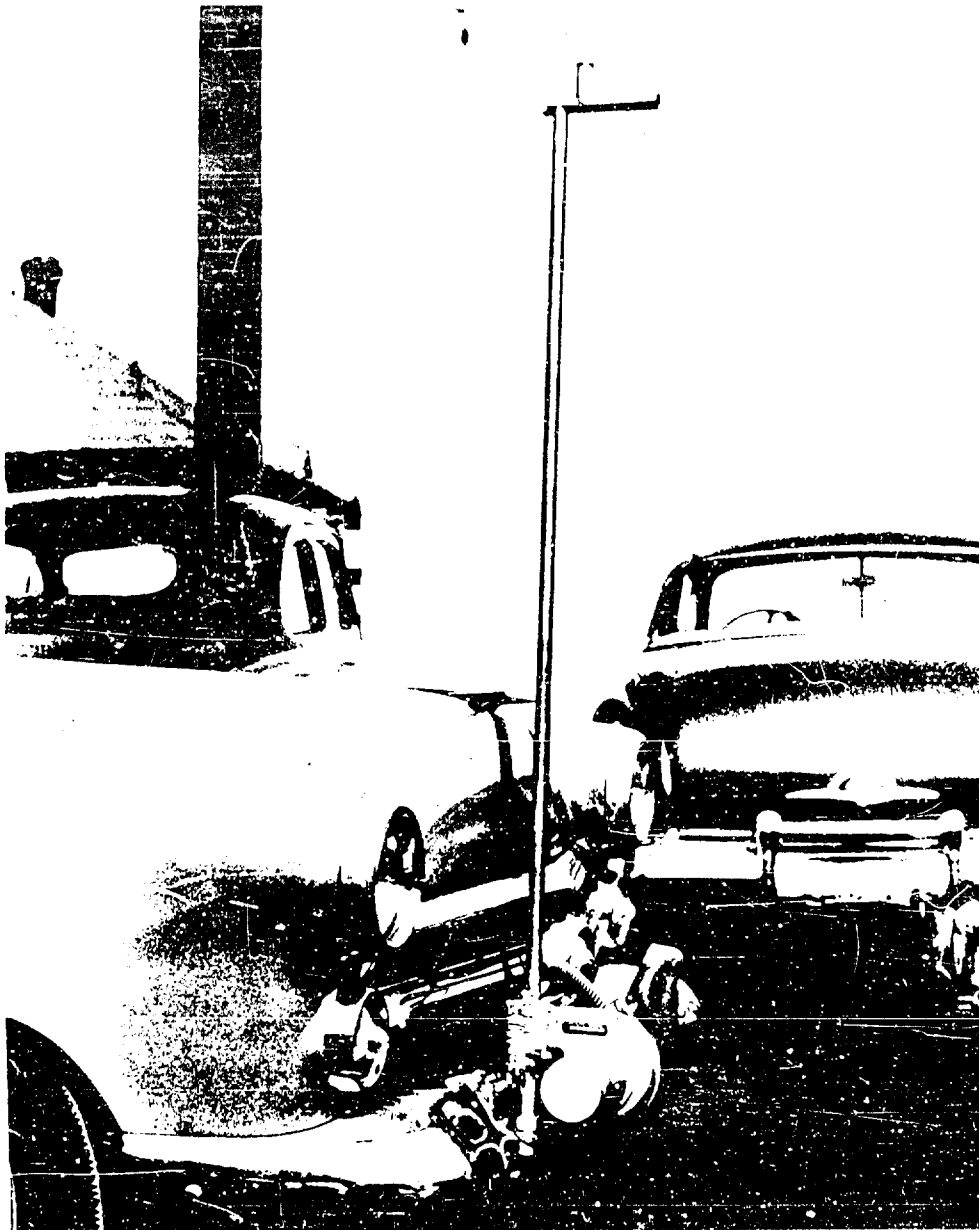
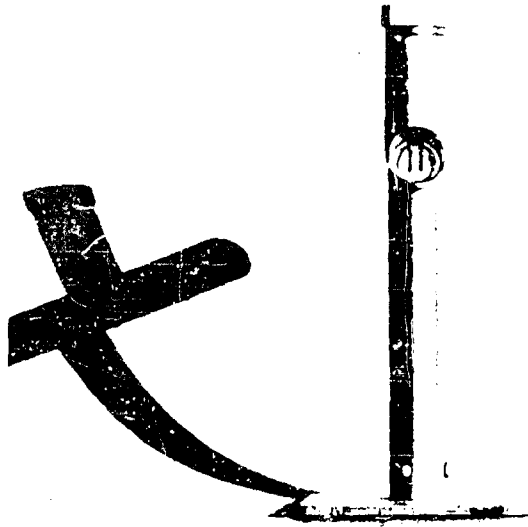
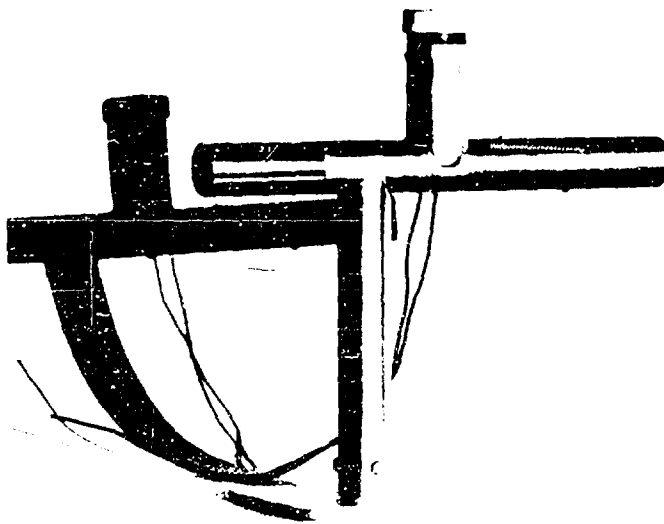

Fig. III-9 Aspirated Automobile Thermistor Mounting Unit



A) End View Showing Thermistor Sensing Element in Place



B) Side View

Fig. III-10 Aspirated Aircraft Thermistor Mounting Unit



Fig. III-11 Temperature Indicating Bridge

IV. FIELD OPERATIONS

A. TEMPERATURE SURVEY PROCEDURES

Before evaluation can be made of aerosol cloud behavior within Minneapolis and St. Louis, proper sites for conducting fluorescent-particle tracer tests must be selected. The basis for such selection is provided by temperature surveys in which measurements of the horizontal temperature gradient are taken. When feasible, simultaneous measurements are also taken of the vertical temperature gradient, thus making possible a three-dimensional picture of the temperature structure. From the derived urban thermal pattern, representative areas can be chosen for evaluating urban effect upon aerosol behavior. The procedures for making temperature surveys are briefly described below.*

Horizontal air-temperature measurements are obtained at the two-meter level by the car-mounted sensing elements described above in Section III.** To enable interpolation of data to a common time-interval, automobile traverses over a predetermined route are restricted to one hour. Thermistor readings are taken while the car is in motion, usually at the midpoint of alternate blocks in the residential and open

* For detailed descriptions of the procedures, see "Outline of Mesometeorological Survey Procedures", Memorandum No. S-6, and Stanford Quarterly Reports 450-6 and 1856-3.

** See also SQR 450-6 and SQR 1856-3.

IV. FIELD OPERATIONS (Continued)

areas, and at every block in the downtown area.

Measurements of the vertical temperature gradient are taken by means of wiresonde equipment including a balloon-suspended thermistor. A cable and reel assembly connects the thermistor to a bridge circuit for indicating temperature, and also permits the operator to regulate and measure the elevation of the thermistor. In built-up areas, wiresonde operations are conducted from the top of a building; the possibility that the balloon or cable will become entangled in power wires, or hit other buildings, is thus minimized. To determine temperatures between ground and roof levels, the thermistor is lowered over the side of the building by rod-and-reel equipment, and readings are taken at given intervals between the roof and the ground.

Operational difficulties and the resulting revisions in the instrumentation program have been cited in Section III. It was found, for instance, that the wiresonde equipment often gave inaccurate values at altitudes above 200 feet. Subsequent investigation revealed that the equipment had not been grounded properly and that a nearby television tower was affecting the thermistor and bridge circuit. Proper grounding solved the problem.

B. TEMPERATURE SURVEYS IN MINNEAPOLIS AND ST. LOUIS

To December 31, 33 temperature surveys were conducted in Minneapolis.

IV. FIELD OPERATIONS (Continued)

The first 24 were made for purposes of orientation and training of personnel and for obtaining background on the urban temperature pattern. To secure representative data, automobile traverse routes were frequently revised.

In Table IV-1 are listed the last nine surveys conducted in Minneapolis in October, November and December, 1952. The wiresonde ascents for measuring vertical temperature gradients are also indicated. In November these ascents were discontinued when low temperatures interfered with successful operation of the equipment.

Table IV-2 summarizes the 17 temperature surveys made of St. Louis. The first six were exploratory in nature and on a limited scale; the remaining 11 surveys were conducted to determine representative routes for obtaining valid field test data. Since priority was given to the results obtained in Minneapolis, it has not yet been possible to evaluate the St. Louis data.

SECRET
SECURITY INFORMATION

TABLE IV-1

TEMPERATURE SURVEYS IN MINNEAPOLIS
October-December 1952

Temp. Survey No.	Date 1952	No. of Maps	Time CST	Soundings: No. and Location	No. Cars and Runs
M-25	10/24	3	2000 2100 2200	3 Urban	2-4
M-26	10/27	3	"	0	2-4
M-27	10/28	3	"	1½ Urban	2-4
M-28	10/29	3	"	2 Urban	4-4
M-29	10/30	3	"	2 Urban	4-4
M-30	10/31	3	"	0	4-4
M-31	11/3	3	"	0	4-4
M-32	11/5	3	"	0	4-4
M-33	12/12	2	2000 2100	0	1-3

SECRET
SECURITY INFORMATION

TABLE IV-2

TEMPERATURE SURVEYS IN ST. LOUIS
November-December 1952

Temp. Survey No.	Date 1952	No. of Maps	Time CST	Soundings: No. and Location	No. Cars and Runs
M-1001	11/13	2	2100 2200	0	2-3
M-1002	11/14	3	2000 2100 2200	0	4-4
M-1003	11/15	3	"	0	2-4
M-1004	11/18	3	"	0	4-4
M-1005	11/19	3	"	0	4-4
M-1006	11/20	3	"	0	4-4
M-1007	11/25	3	"	0	3-4
M-1008	12/2	3	"	0	3-4
M-1009	12/4	3	"	0	4-4
M-1010	12/5	3	"	0	4-4
M-1011	12/9	3	"	0	4-1
M-1012	12/10	3	"	0	3-4
M-1013	12/11	3	"	0	3-4
M-1014	12/12	3	"	0	4-4
M-1015	12/15	3	"	0	3-4
M-1016	12/16	3	"	0	4-4
M-1017	12/17	3	"	0	4-4

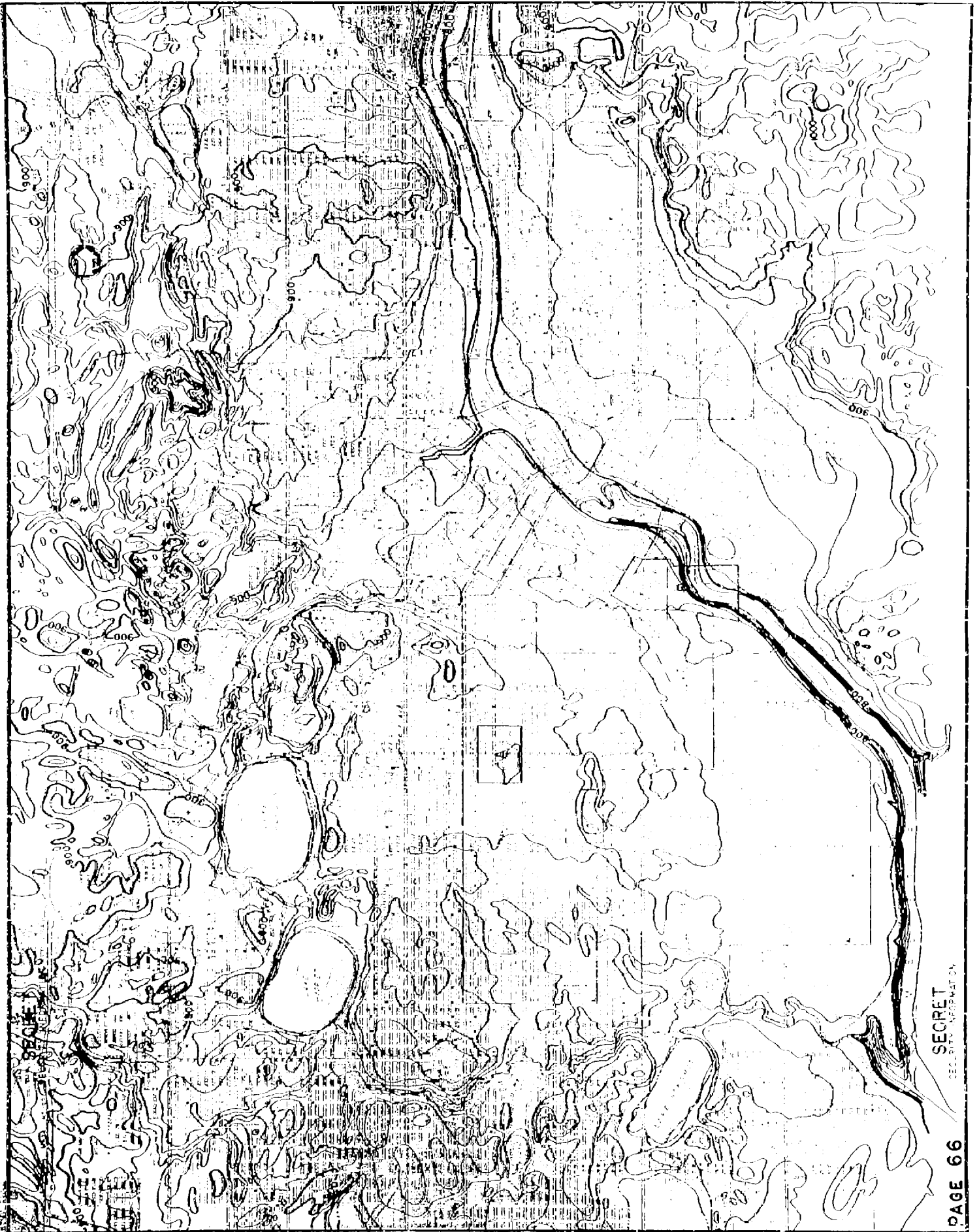

SECRET
SECURITY INFORMATION

Fig. V-1

Topographic Map of Minneapolis

Contours at 20-foot intervals are shown in black. Proposed tracer test areas A and B and temperature survey routes AG, AH, AI and AJ are shown in red.

V. RESULTS AND DISCUSSION

A. SUMMARY OF RESULTS OBTAINED FROM FOUR MINNEAPOLIS SURVEYS

During the current period, evaluation was made of the four temperature surveys completed in Minneapolis between 24 and 30 October 1952, each resulting in isotherm charts for 2000, 2100, and 2200 hours GST. In the first two surveys, M-25 and M-26, a relatively loose network of data was obtained with two cars; in the remaining surveys, M-27 and M-29, more intensive coverage was achieved with four cars. The routes traversed in the four-car survey (Fig. V-1) are based on the results of preliminary runs in Minneapolis and on the findings obtained in similar surveys of other cities. Since the automobiles employed in the four surveys did not traverse the whole city, certain regions of uncertainty remain. Isotherms for these regions have been drawn on the basis of experience gained from surveys conducted elsewhere and are indicated as dashed rather than solid lines.

In addition to readings of the horizontal temperature gradient, five vertical temperature sounds, included in surveys M-25 and M-27, were obtained from the 25-foot high roof of the Minneapolis Field Office, just outside the downtown area.

For each survey, the applicable St. Cloud raw sounding, the urban wiresonde data, the summary of the synoptic situation, and the isotherm

V. RESULTS AND DISCUSSION (Continued)

chart or charts are presented in the Appendix. Of the 12 isotherm charts obtained from the four surveys, six are reproduced in the Appendix, one each for surveys M-25, M-26, and M-27, and three for M-29, which showed the greatest urban effect under conditions of low wind speeds and virtually clear skies. M-27 was characterized by similar conditions. The remaining two surveys were marked by wind speeds ranging from 12 to 19 mph, with clear and overcast skies for M-25 and M-26, respectively. The significance of these wind data, in terms of the respective temperature differentials, will be noted presently.

The prevailing meteorological conditions described above are listed in Table V-1, which defines horizontal gradient measurements in numerical terms, for purposes of correlation, and which describes the vertical gradient measurements from street to roof levels as superadiabatic, adiabatic, lapse less than adiabatic, isothermal, and inversion.

The symbols used to describe the chart situations are defined as follows:

- T_{max} = The highest reported temperature at chart time in the area traversed, almost always located in or near the business district and defining the center of the heat island.
- T_{min} = The lowest reported temperature at chart time in the area traversed, almost always appearing at some point on the peripheral open lands.

V. RESULTS AND DISCUSSION (Continued)

- D_T = The difference between maximum and minimum observed temperatures in the traversed area.
- T = The mean temperature at chart time, based on a simple arithmetic mean of T_{max} and T_{min} .
- $[R/\Delta T]_{min}$ = A measure of the minimum distance one must travel from the center of the urban heat island before encountering a temperature drop of $1^\circ F$. R is a radius of a circle around the center of the urban heat island. This radius is chosen so that it includes the most densely built-up area within the city and equals 1.5 miles for Minneapolis. ΔT is the difference in temperature between the center and any point on the periphery of this circle; therefore, to find the minimum value for $R/\Delta T$, the maximum observed value of ΔT is used in the quotient.

The minimum radius per $^\circ F$, symbolized by $[R/\Delta T]_{min}$, sweeps out a circular area which is proportional to the area over which a centrally located wire-sonde observation may be considered representative. This expression, which has the dimensions of a reciprocal temperature gradient, has been used as a criterion of the heating effect of the most densely built-up portion of several California cities. The usefulness of this and similar criteria can be established only after data from more cities have been analyzed, especially since the extent of the densely built-up area in each city determines the particular value of R in the above expression.

The other meteorological data presented for comparison in Table V-1 were obtained from continuous recordings made at the Wold-Chamberlain Field, eight miles south of the city center. Entries for headings described below are the readings taken half an hour following the respective traverse times listed in the table.

V. RESULTS AND DISCUSSION (Continued)

Wind Speed and Direction: All wind instruments at the airport were located 62 feet above ground.

Survey Clouds: Cloudiness is indicated in the standard airway descriptive terms: clear (O), scattered (⊕), broken (⊖), and overcast (⊕), with cloud bases given in hundreds of feet.

Diurnal Temperature Range: The diurnal range given here is most representative of the period including a given temperature survey. Thus, since all surveys were made at night, the range is taken from the maximum during the afternoon preceding the survey to the minimum in the early morning following it.

TABLE V-1

SUMMARY OF DATA FROM MINNEAPOLIS TEMPERATURE SURVEYS

General		Horizontal Temperature Survey Data				Vert. Temp. Grad.		Other Meteorological Data					
Survey No.	Date	Time CST	T _{max}	T _{min}	D _T	T̄	R/T	Sfc. to 20' roof	20' roof to 100'	Wind Speed	Dir.	Survey Clouds	Temp. Range
M-25	10-24-52	2000	63.5	56.8	6.7	60.2	0.41	SuA.	Lap.	13	E	0	30
"	"	2100	62.4	54.8	7.6	58.6	0.31	Lap.	Lap.	13	E	0	30
"	"	2200	60.8	52.6	8.2	56.7	0.33	SuA.	Iso.	12	E	0	30
M-26	10-27-52	2000	34.5	31.3	3.2	32.9	0.71	—	—	19	WSW	40 ⊕	16
"	"	2100	33.6	31.2	2.4	32.4	1.00	—	—	15	WSW	35 ⊕	16
"	"	2200	33.2	30.7	2.5	31.9	0.79	—	—	19	WSW	34 ⊕	16
M-27	10-28-52	2000	37.2	21.6	15.6	29.4	0.22	SuA.	SuA.	8	WSW	0 0	16
"	"	2100	35.2	19.6	15.6	27.4	0.34	SuA.	SuA.	6	WSW	0 0	16
"	"	2200	35.0	19.5	15.5	27.2	0.19	—	—	2	SSW	0 0	16
M-29	10-30-52	2000	59.6	42.8	16.8	51.2	0.14	—	—	8	SSW	150-⊕	27
"	"	2100	58.8	40.8	18.0	49.8	0.17	—	—	5	SW	150-⊕	27
"	"	2200	56.8	41.8	15.0	49.3	0.21	—	—	8	WSW	150-⊕	27

V. RESULTS AND DISCUSSION (Continued)

B. DISCUSSION OF URBAN THERMAL STRUCTURE

1. City Structure and Terrain

Before the results of the temperature surveys can be discussed, a brief description of the terrain and physical structure of the city is necessary. Minneapolis is located on the Mississippi River, approximately 25 per cent of the city being on the eastern side. For the most part, the built-up area extends to the river banks, which are fairly steep and rise about 100 feet above the water surface. Within the city itself the terrain is flat to gently rolling. As indicated by the topographic map (Fig. V-1), the central and southern districts are quite flat, varying in elevation from 800 to 900 feet above sea level. A low strip runs approximately from Cedar Lake northeast to the river at elevations approximately 800 to 840 feet. The northern section of the city is somewhat more irregular than the southern with elevations varying from 800 feet along the river to a maximum of 940 within the city.

The relation between the car routes and the topography is also indicated in Figure V-1. With four cars the routes were distributed in such a way that each car covered a segment of the downtown area as well as a part of an outlying district. All of route A-I lay between 840 and 880 feet; A-J varied from 800 to 960 feet; A-G, from 800 to 920 feet; and A-H, from 800 to 900 feet. Routes A-G and A-J included undeveloped areas.

V. RESULTS AND DISCUSSION (Continued)

When traverse equipment for only two cars was available, routes A-G and A-H were used.

Lakes and rivers comprise approximately 10 per cent of the city area and an even greater per cent of the immediately surrounding country. Minnetonka, the largest of the peripheral lakes, is irregular in shape and covers approximately 25 square miles. Ten miles east of Lake Minnetonka is Lake Calhoun, the largest of the ten lakes in the southern part of the city. These vary in size from a city block to a maximum of 0.8 by 1 mile for Lake Calhoun. Most of the smaller lakes are surrounded by parks.

The principal downtown section, around Nicollet and Sixth Streets, covers approximately 1.5 square miles. Portions of this area including the principal buildings are shown in the frontispiece. The area is less densely built-up than downtown San Francisco (see Fig. 1, SQR 1856-3), and features broad streets and numerous open parking lots.

The residential area, consisting of many tree-covered streets, is characterized by two and three-story dwellings.

2. Characteristics of the Horizontal Temperature Pattern

a. Isotherm Patterns and Their Reproducibility

Isotherm patterns obtained to date in Minneapolis show characteristic

V. RESULTS AND DISCUSSION (Continued)

patterns similar to those examined in other cities including Palo Alto, San Jose, and San Francisco. The highest temperatures are always found in or near the downtown area. Lowest temperatures are found outside the city or, in some instances, near the larger parks or undeveloped areas. In all surveys except M-26, which was conducted under high wind conditions associated with an overcast sky, the downtown warm area is clearly defined. In addition, Columbia Park, Wirth Park, and the area north and west of Lake Hiawatha appear to be consistently cold. This distribution of temperature is apparent on all three charts for survey M-29 (Figs. A-10, A-11, and A-12, in the Appendix) as well as on the three charts for M-27, one of which, Figure A-8, appears in the Appendix. Between the warm and cold areas the pattern is less defined and varies from night to night. However, the area south of the business district is usually associated with the small horizontal temperature gradient for a distance of approximately one mile.

The magnitude of the temperature difference D_T is apparent in Table V-1. In M-26, when the wind velocity (measured at the airport) varied from 15 to 19 mph and the sky was overcast, the observed temperature difference was approximately 2.5° F. In M-25 the temperature difference was 6 to 8° F with clear skies but with wind speeds of 13 mph. In M-27 and M-29, the temperature differential exceeds 15° F; in each case the airport wind velocity was 8 mph or less.

V. RESULTS AND DISCUSSION (Continued)

b. Effect of Wind Velocity on the Isotherm Pattern

As pointed out earlier, the wind data presently available are taken at the airport located 2 1/2 miles southeast of Lake Hiawatha. The direction and velocity equipment is 62 feet above the ground. Within the city itself, velocities at the two-meter level are undoubtedly lower than those shown at the airport station and, in fact, may be as low as one-half the represented value. Under high wind conditions the airport wind direction is probably representative of the entire city.

The isotherm pattern is affected in two ways by the wind: first, at high velocities the temperature differences are greatly reduced; and second, the isotherm pattern is displaced somewhat in the downwind direction.

The first effect is shown for 2100 hours, 27 October 1952, in survey M-26 (Fig. A-5). On this night the wind was blowing from the northwest between 15-19 mph. The resulting temperature gradient was small, amounting to only 2.5° F. The same situation existed for the 2000 and 2200 hour charts, neither of which is included in the Appendix. On this night the overcast sky as well as the high wind was a factor in reducing temperature gradient. In addition the average cloudiness during the day amounted to 60%, which would reduce the amount of heat available for storage within the city and would in turn tend to minimize the night-time horizontal

V. RESULTS AND DISCUSSION (Continued)

temperature differential. This effect, however, may be of secondary importance since a large differential was observed in M-29 although the day-time cloudiness amounted to 70%. In M-25 with a wind speed of 12 to 13 mph, the temperature difference increased to 7.6° F. Temperature differences of 15° F and greater were observed in M-27 and M-29, where the wind was 8 mph or less.

The shift in the isotherm pattern was particularly noticeable in the downtown area. As indicated in Figures A-10, A-11, and A-12, for M-29, it was first displaced to the north and later to the northeast as the wind shifted from the south to the west-southwest. A similar displacement is shown in Figure A-8 (M-27), where the wind is west-southwest. The isotherms from this chart have been re-plotted on the frontispiece, where they clearly indicate the downwind displacement from the most densely built-up area. Survey M-25 also shows a pronounced displacement, this time toward the west because of an easterly wind (Fig. A-3). The 2000 and 2200 charts, not included in the Appendix, show the same effect.

c. Effect of Terrain

Based on available data, the effect of terrain appears to be small, when height and the effect of cover are considered. Thus, the small warm zone south of Crystal Lake Cemetery which appears on all three charts for survey M-29 may be due to higher ground in that area when inversion conditions

V. RESULTS AND DISCUSSION (Continued)

prevail. The three charts also show isolated warm zones in the north-east edge which may likewise be due to slight changes in elevation. Finally, all of the charts indicate that southwest of Wirth Park there is a pronounced temperature gradient which is apparently due to an 80-foot slope rising away from the lake.

Large areas of open ground are consistently cold. In addition to Columbia Park and Wirth Park mentioned above, the area southeast of Columbia Park appears cold in both M-29 and M-27, including the two M-27 charts not reproduced in the Appendix.

The measurements obtained to date do not show a pronounced reproducible effect from the Mississippi River.

Lake Calhoun, the largest lake within the city, has a small but measurable effect under some conditions. When the air temperature is less than the water temperature, as in Figure A-8 (M-27), the air temperature increased from the upwind to the downwind side of the lake. In this particular case the air temperature was approximately 27° F, whereas the lake as measured close to shore on the north edge was 44° F. The isotherms appear to be perpendicular to the wind across the lake and show approximately 3° F of warming. In M-29 the air was only 4° F warmer than the lake and showed no significant modification as it moved across the water.

V. RESULTS AND DISCUSSION (Continued)

d. Effect of Environmental Temperature

Temperature survey M-27 was conducted in below-freezing temperatures in contrast to the other surveys which were made between 30° and 60° F (Table V-1). From these data it appears that the isotherm patterns are not affected by low temperatures. Surveys M-27 and M-29, which were conducted under similar wind conditions but at 20° and 40° F respectively, gave very similar patterns and temperature differentials. Winter surveys, however, may show a change in the temperature pattern particularly after the lakes have frozen and the ground has been covered with snow.

3. Comparison with Other Cities

A comparison of presently available temperature patterns for Minneapolis with patterns from other cities indicates that the Minneapolis results are in agreement with those to be expected of a city of its size and population density. Table V-2 contains a brief summary of the city characteristics and the temperature differences and temperature gradients. Minneapolis is somewhat larger in area than San Francisco but has a smaller population; in this respect its population density value falls between those of San Francisco and San Jose.

TABLE V-2

HORIZONTAL TEMPERATURE PATTERN CHARACTERISTICS
COMPARED WITH
VARIOUS INDICES OF CITY SIZE

	<u>San Francisco</u> ¹	<u>San Jose</u> ¹	<u>Palo Alto</u> ¹	<u>Minneapolis</u>
Population	784,000	101,000	33,000	522,000
Incorporated Land Area, square miles	45.1	14.8	8.6	58.8 ²
Population Density, persons/square mile	17,300	6,800	3,800	8,900
Maximum Temperature Differ- ence (D_T) $T_{max} - T_{min}$ (°F)	20.0	14.2	12.6	18
Minimum $R\Delta T$, $mi./°F^3$	0.179	0.143	0.054	0.14

¹ Extracted from SQR 1856-3, p. 46.

² This figure includes 5.3 square miles of lakes and rivers.

³ See definitions of symbols used in Table V-1 for discussion of $R\Delta T$.

V. RESULTS AND DISCUSSION (Continued)

The maximum observed temperature difference (D_T) and the minimum temperature value ($R/\Delta T$) are also within the limits given for San Francisco and San Jose. For the three cities in the San Francisco Bay Area, average values of the temperature gradient were approximately one-half the maximum, and average values of the ratio $R/\Delta T$ were two to three times greater than the minimum. As indicated in Table V-1, measured values of D_T and $R/\Delta T$ for Minneapolis covered the above range but until additional tests have been run and additional meteorological data obtained in the city proper, it is difficult to arrive at representative average values.

As pointed out earlier, the distribution of warm and cold areas agrees qualitatively with that found in other cities. However, the M-29 surveys show a warming in certain areas late in the evening; such nocturnal warming has not been observed in preceding temperature surveys either of Minneapolis or of other cities except in one survey of Palo Alto which was associated with the onset of a stratus overcast. The warming is most pronounced at the edges of the city, at Columbia Park, Crystal Lake Cemetery, Wirth Park, Lake of the Isles, and south of Lake Calhoun. Between 2100 and 2200 hours the temperature increased 2-3° F in those areas and 5° F west of Wirth Park. During the same period both at the airport and in the downtown area, the temperature dropped between 1.5° and 2° F.

From 2100 to 2200 hours the wind velocity varied from 5 to 8 mph, with a

V. RESULTS AND DISCUSSION (Continued)

wind shift from south-southwest to west-southwest. If the airport wind is representative of the entire area, a westerly shift might be expected to bring into the western side of the city cooler air which would lower rather than raise the temperature. Additional surveys are needed to determine the cause of the observed rise in temperature.

4. Vertical Temperature Gradients

Measurements of vertical temperature gradients with wiresonde equipment are available for surveys M-25 and M-27. The results are summarized in Table V-1 and are presented diagrammatically in the Appendix.

In both M-25 and M-27, gradients were measured from the ground to approximately 200 feet and in each case were taken from a roof in the downtown area. The exact position is indicated on the isotherm charts and also in the frontispiece. A large kytoon was used to carry the thermistor above roof level; between the roof and ground, measurements were made by lowering the thermistor over the side of the building.

Figure A-2 presents the three soundings for M-25 which correspond in time to the three horizontal temperature charts for that survey. In each case the soundings show an instability in the lowest 10 to 15 feet, with an irregular gradient above this level. In the earliest run the average gradient above 25 feet is almost adiabatic. The later runs show increasing stability reaching approximately isothermal at 2200 hours from 25 to

V. RESULTS AND DISCUSSION (Continued)

200 feet. Cooling takes place throughout the 200-foot layer between 2000 and 2200 hours.

M-27 soundings taken at 2000 and 2045 hours (see Fig. A-7) correspond closely in time to the first two isotherm charts. In each case instability is indicated from ground to the upper limit of the sounding. At the roof level, particularly in the second sounding, there is shown a pronounced discontinuity which probably arises from the measuring procedure.* For purposes of analysis the two sections of the curve should be joined at the roof level.

It is interesting to note that none of the five wiresondes obtained was run in the warmest portion of the downtown area. The wiresonde position at 2100 hours for M-25 (Fig. A-3) was at least five blocks from the 62° F isotherm. It was approximately the same distance away in the 2000 and 2200 hours on the charts (not included in the Appendix). In M-27, Figure A-8, the wiresonde position was likewise at least four blocks from the warmest area. The distance is readily apparent in the frontispiece. Thus, while the soundings obtained indicate considerable instability in the downtown area, the degree of instability is probably not the maximum which may have existed.

* See SQR 1856-3, p. 56, for discussion of this point.

V. RESULTS AND DISCUSSION (Continued)

The closest radiosonde ascents to Minneapolis are made at St. Cloud, about 60 miles to the northwest and 200 feet higher in elevation. The distance between these cities is such that actual temperature differences of several degrees Fahrenheit might be found in soundings at the two stations, but in the absence of frontal discontinuities the St. Cloud raob data should indicate reasonably well the degree of atmospheric stability over the open land surrounding Minneapolis. Thus, for each of the four temperature surveys reported here, St. Cloud raob data from the surface to 5000 feet msl (about 4000 feet above the surface) are given for 2100 CST, corresponding to an isotherm chart, and for the preceding and following mornings at 0900 CST.

On the night of survey M-26, raob data (Fig. A-4) showed nearly adiabatic conditions in the lowest 4000 feet, and pibal data showed winds above the friction layer at 30-40 mph from the northwest. With northwest surface winds of 15-20 mph reported at Minneapolis airport, similar adiabatic conditions would be expected adjacent to that city, and the small horizontal temperature differential of 2-3° F observed across the city would support the absence of inversion conditions over open land.

On the nights of surveys M-27 and M-29, surface inversions of considerable magnitude were shown in the St. Cloud raob data (Figs. A-6 and A-9), and synoptic maps indicated that similar conditions should exist across

V. RESULTS AND DISCUSSION (Continued)

the state of Minnesota. On both nights winds at Minneapolis airport were 8 mph or less, and large horizontal temperature gradients were observed across the city. For survey M-29, raob data showed a 14° F inversion from the surface to 900 feet, and an urban differential of 18° F established the record to date for Minneapolis. During survey M-27 an 11° F surface inversion at St. Cloud extended to 400 feet, and across Minneapolis an urban differential of $15-16^{\circ}$ F was reported. Moreover, wiresonde data for survey M-27 (Fig. A-7) showed strong lapse conditions from the surface to 200 feet in downtown Minneapolis, despite the strong surface inversion which the horizontal gradient would indicate to have extended to the fringes of the city.

A weak, dry cold front, characterized primarily by wind and temperature discontinuities, passed over the Minneapolis region on the night of survey M-25, so that special caution must be exercised in applying St. Cloud raob data (Fig. A-1). On the St. Cloud soundings for the following morning (25 October 1952), the strong 17° F inversion between 1000 and 2000 feet defines the frontal surface. Nevertheless, the 8° F surface inversion observed at St. Cloud during the survey compares well with the 8° F urban differential observed at Minneapolis, and the intermediate 8° F magnitude of that differential compares well with the intermediate 13 mph wind speed reported at the Minneapolis airport. Wiresonde data

V. RESULTS AND DISCUSSION (Continued)

(Fig. A-2) indicated superadiabatic conditions in the lowest 200 feet over downtown Minneapolis on this night, whereas inversion conditions in all probability existed outside the city.

Direct evidence from survey M-27 and supporting evidence from surveys M-25 and M-29 indicate that instability may exist within an urban area at times when inversions have developed over the area surrounding it. In this respect the results are in accord with those for Palo Alto, San Jose, and San Francisco.

G. APPLICATION OF TEMPERATURE SURVEY RESULTS TO SELECTION OF SITES FOR
AEROSOL CLOUD STUDIES

The results of the temperature surveys were used in conjunction with aerial photographs and a topographic map to select areas within Minneapolis suitable for aerosol cloud studies using the fluorescent tracer technique.*

Several test areas are required, ranging in size from 1/4 to 1 square mile. One of these should be as typical as possible of the major portion of the built-up part of the city, including commercial and residential structures, and should be as representative as possible of probable target areas. The others should include characteristic elements of the

* See Joint Quarterly Report No. 1, Section III.

V. RESULTS AND DISCUSSION (Continued)

city such as the downtown district with its tall structures, a portion of the city adjacent to the river with a density of structures comparable to the first area mentioned, and an open site to provide data which may be compared directly with results from Dugway Proving Ground.

Most of the testing effort will be devoted to the area representative of the major part of the city. In addition to the structural qualifications described above, the area should have:

- a) A minimum horizontal temperature gradient across it;
- b) Reasonably level terrain;
- c) A uniform building density and a surrounding region of similar composition.

An area 1/2 mile on a side meeting these requirements was selected approximately 1-1/2 miles south of the central business district. It is marked Area A in Figure V-1 and is bounded by 27th Street, 31st Street, Stevens Avenue, and Oakland Avenue. It is primarily a residential area with a population density of 20,500 persons per square mile. In addition, there are a shopping and commercial district along one street and a few manufacturing plants, most of which are two stories or less.

A second test area (identified as Area B, Fig. V-1.) was tentatively selected along the river. It is similar to the first in that it includes residential and commercial structures. The population density in the

V. RESULTS AND DISCUSSION (Continued)

built-up area is also comparable. It is bounded by 11th Avenue South, 6th Street South, Harvard Street (projected across the river to intersection of 6th Street), Washington Avenue SE, and 2nd Street South. This location is being considered as a site which will provide information on the effect of the river on cloud behavior; results obtained here will be compared with those in the first area. However, before final selection is made of Area B, more detailed examination is necessary.

Other test sites under consideration include the central downtown district and a flat open area on the outskirts of the city such as Fort Snelling. These areas will be selected as soon as results are obtained from the first area.

A P P E N D I X

FIGURE A-1

WINDS ALOFT
ST. CLOUD PIBAL
24 OCTOBER 1952
2100 CST

TEMPERATURE SOUNDINGS
ST. CLOUD RA05, 24 OCT. 1952
(SUPPLEMENTAL TO SURVEY M-25)

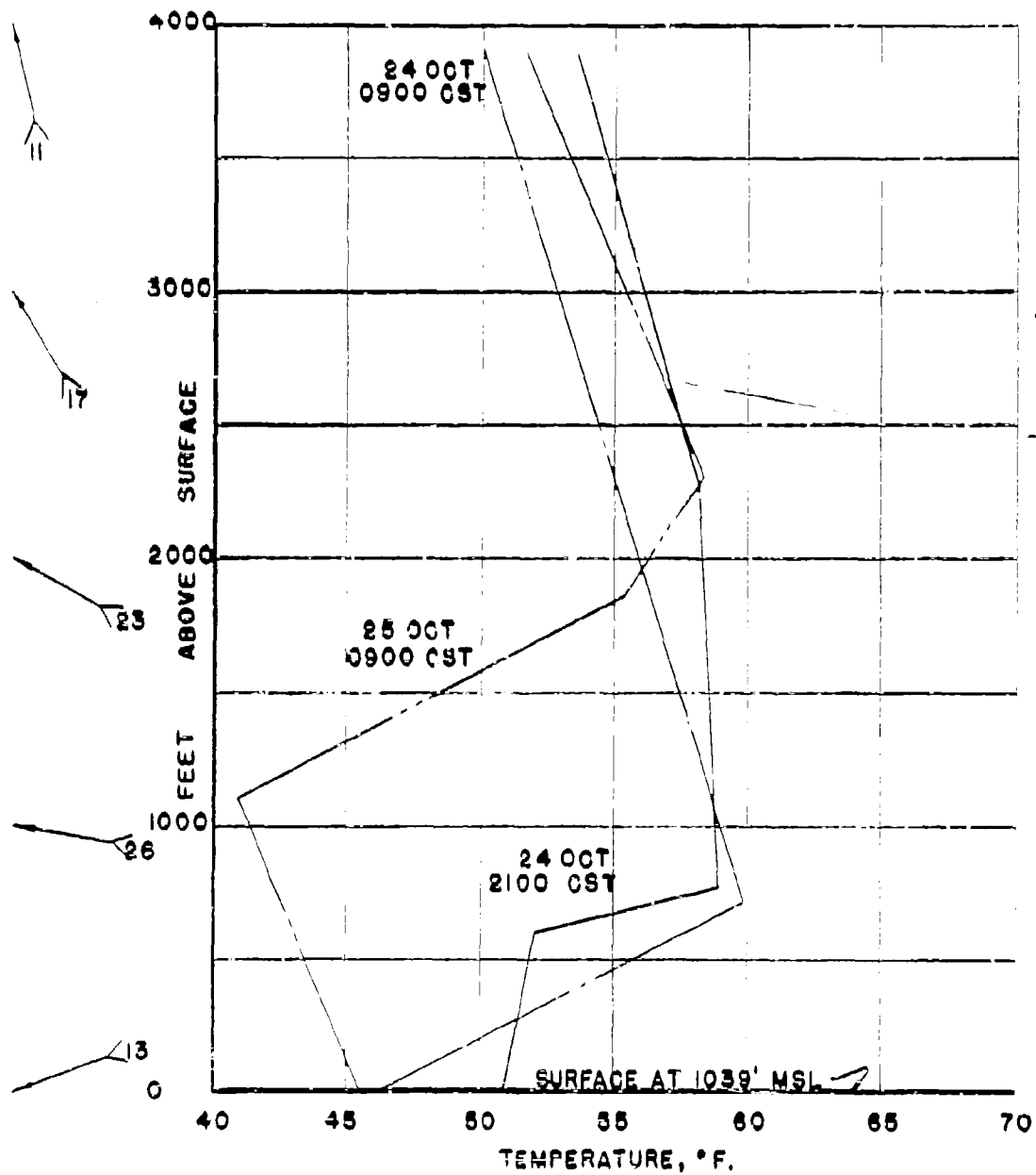
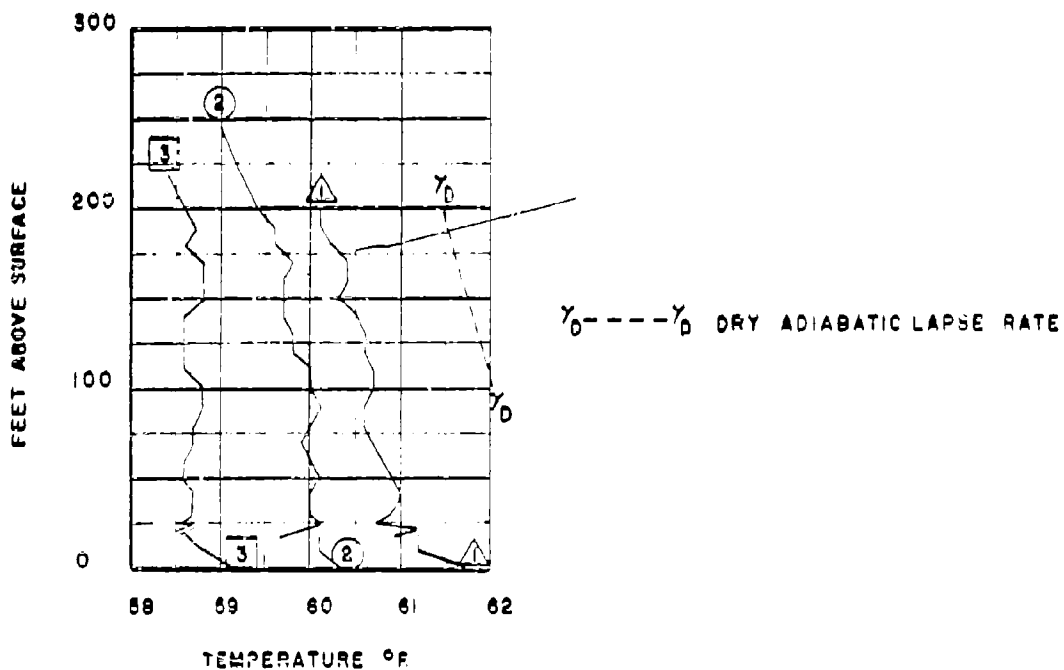

FIGURE A-2
TEMPERATURE SOUNDINGS
MINNEAPOLIS URBAN WIRESONDE
SURVEY M-25, 24 OCT 1952

- △ 2000 GST (2 HR 45 MIN AFTER SUNSET)
- ⊙ 2100 GST (3 HR 45 MIN AFTER SUNSET)
- ⊠ 2200 GST (4 HR 45 MIN AFTER SUNSET)



TEMPERATURE SURVEY M-25
(24 October 1952)

Synoptic Situation

A weak cold front, which extended from Massachusetts to Saskatchewan, had passed the Minneapolis area during the afternoon, but was identified only by wind and temperature discontinuities. In eastern Nebraska a weak low-pressure center along this system was weakening rapidly and caused no adverse weather. To the north of Lake Superior was centered a cold polar continental high cell. For the Minneapolis area northeasterly gradient winds thus caused advection of much colder air. At the 700-mb level a weak ridge resulted in a northwesterly gradient wind across the area.

Weather at Wold-Chamberlain Field (Minneapolis Airport)

<u>Time</u> <u>GST</u>	<u>Cloud Ht.</u> <u>(Ft.)</u>	<u>Sky</u> <u>Coverage</u>	<u>Visibility</u> <u>(Mi.)</u>	<u>Pressure</u> <u>(Mb)</u>	<u>Temp.</u> <u>(°F)</u>	<u>Dew</u> <u>Point</u>	<u>Wind</u> <u>Dir.</u>	<u>Wind</u> <u>Speed</u>
1830	25000	Scattered	15	1017.6	64	35	ENE	13
1930		Clear	15	1018.0	61	34	E	15
2030		Clear	15	1018.3	59	32	E	13
2130		Clear	15	1018.3	58	31	E	13
2230		Clear	15	1018.6	58	30	E	12
2330		Clear	15	1018.3	54	30	ENE	14

*Average cloudiness sunrise to sunset (Holman Field, St. Paul): 20%

SECRET
SECURITY INFORMATION

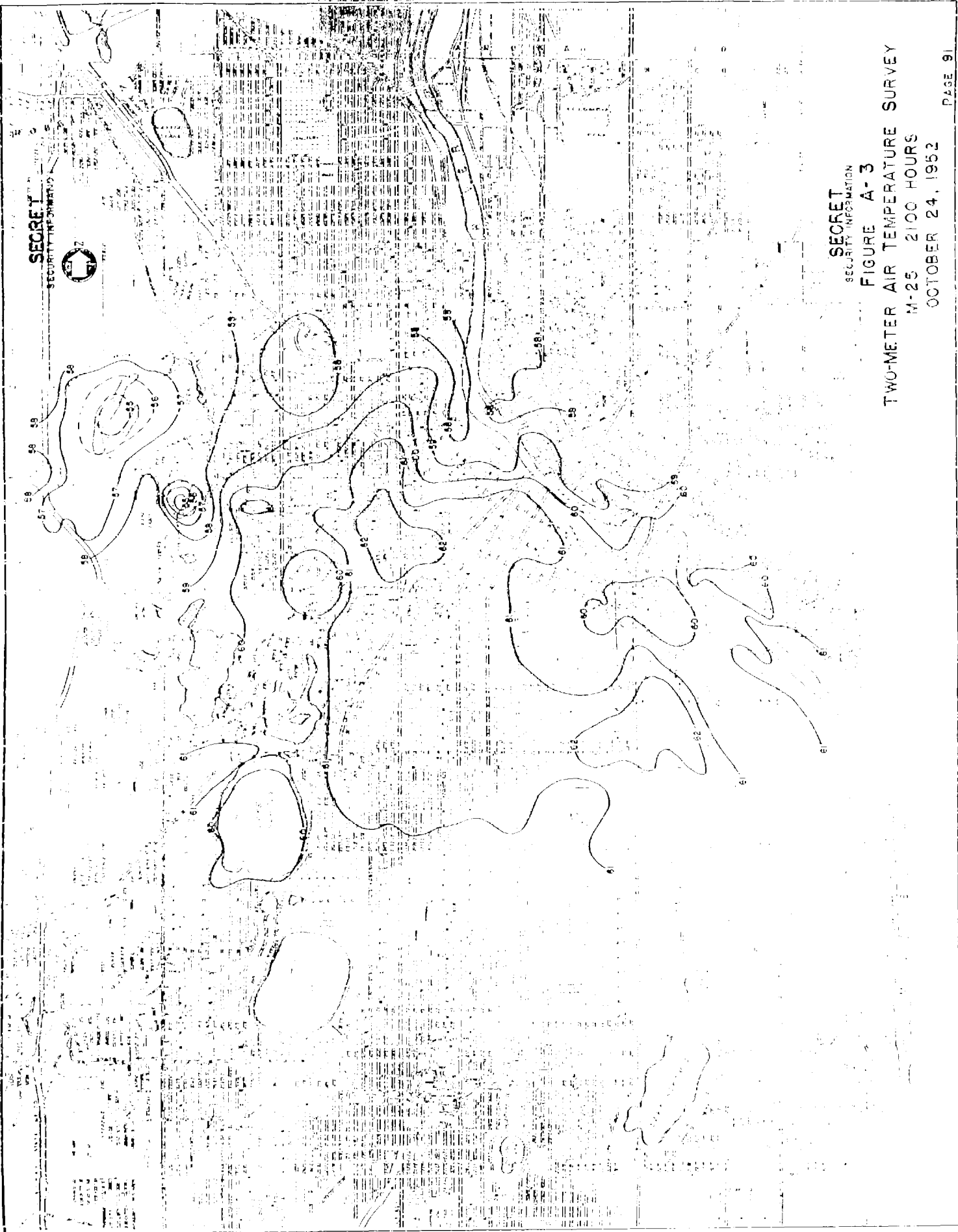

SECRET
SECURITY INFORMATION

FIGURE A-3

TWO-METER AIR TEMPERATURE SURVEY

M-25 2100 HOURS

OCTOBER 24, 1952

FIGURE A-4

TEMPERATURE SOUNDINGS
ST. CLOUD RA08, 27 OCT. 1952
(SUPPLEMENTAL TO SURVEY M-26)

WINDS ALOFT
ST. CLOUD PIBAL
27 OCTOBER 1952
2100 CST

43
41
34
25
10

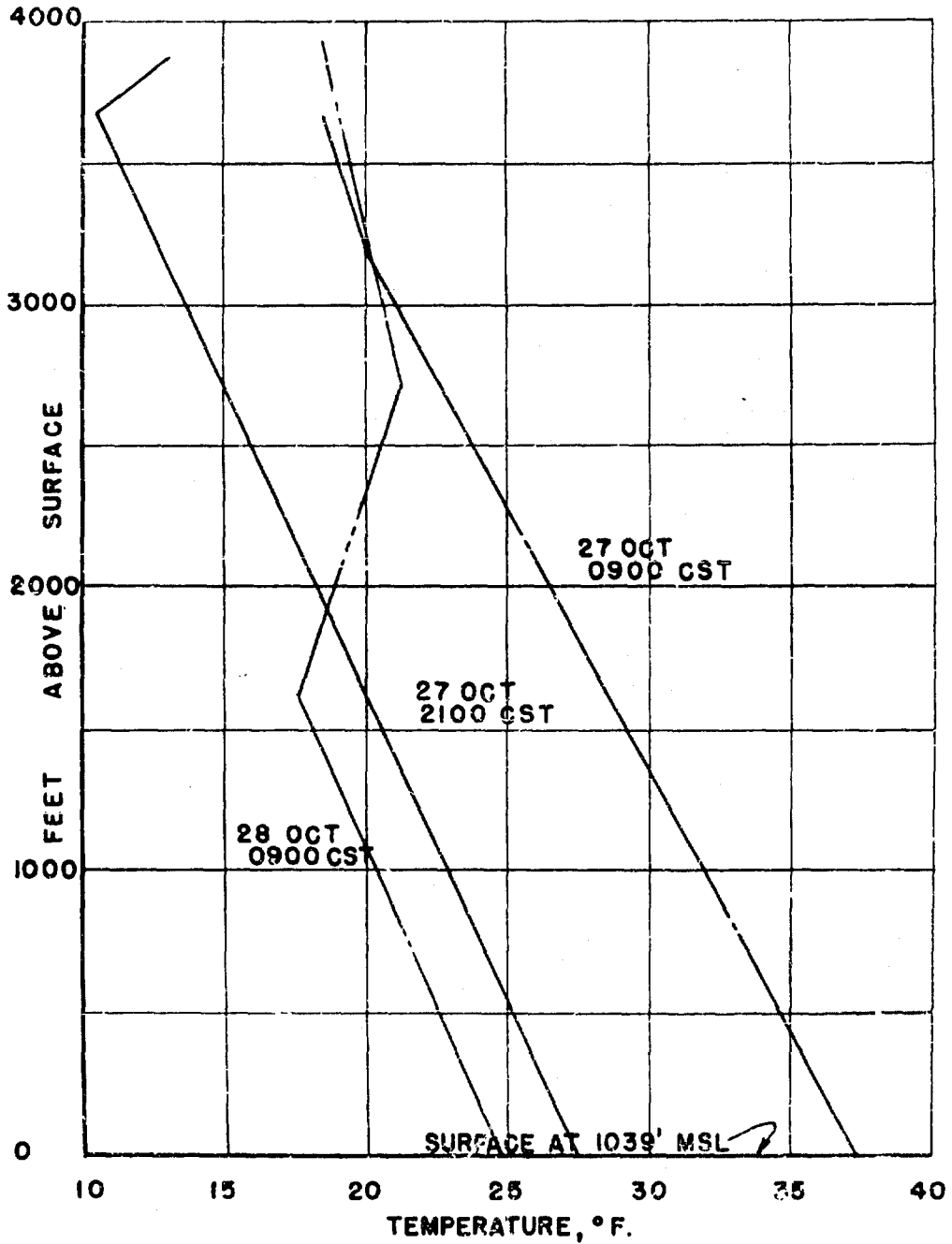

TEMPERATURE SURVEY M-26
(27 October 1952)

Synoptic Situation

An intense high-pressure cell, with a 1037-millibar center over North Dakota, extended from the Appalachians to the Rockies. The cold frontal system along the Appalachians terminated over eastern Canada in a low center which was weakening and moving rapidly eastward. Over Minneapolis northerly gradient winds of 30 knots brought cold polar continental air to the area. At 700 millibars a high-pressure ridge lay over the Rockies, resulting in northwesterly winds at that level over Minneapolis.

Weather at Wold-Chamberlain Field (Minneapolis Airport)

<u>Time</u> <u>CST</u>	<u>Cloud Ht.</u> <u>(Ft.)</u>	<u>Sky</u> <u>Cover*</u>	<u>Visibility</u> <u>(Mi.)</u>	<u>Pressure</u> <u>(Mb)</u>	<u>Temp.</u> <u>(°F)</u>	<u>Dew</u> <u>Point</u>	<u>Wind</u> <u>Dir.</u>	<u>Wind</u> <u>Speed</u>
1830	5000	Scattered	15+	1023.4	34	18	NW	20
1930	4300	Overcast	15+	1024.4	32	20	NNW	20
2030	4000	Scattered	15+	1024.7	32	17	NNW	19
2130	3500	Overcast	15+	1024.7	32	16	NW	15
2230	3400	Overcast	15+	1025.1	31	16	NW	19 Gusty
2330	3400	Overcast	15+	1025.4	31	17	NW	18 Gusty

*Average cloudiness sunrise to sunset (Holman Field, St. Paul): 60%

SECRET
SECURITY INFORMATION



SECRET
SECURITY INFORMATION

FIGURE A-5

TWO-METER AIR TEMPERATURE SURVEY
M-26 2100 HOURS
OCTOBER 27, 1952

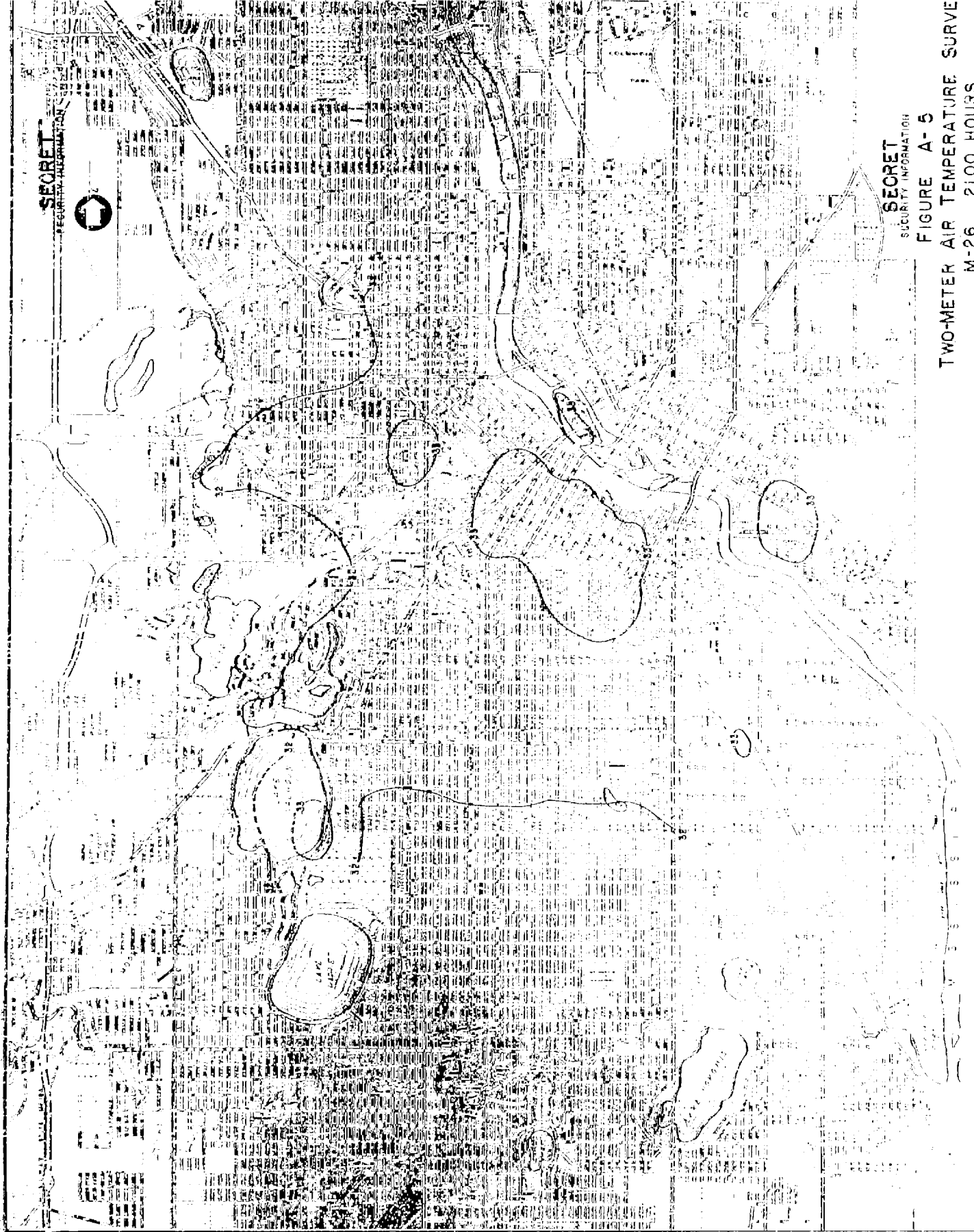

FIGURE A-6

WINDS ALOFT
ST. CLOUD PIBAL
28 OCTOBER 1952
2100 CST

TEMPERATURE SOUNDINGS
ST. CLOUD RA08, 28 OCT. 1952
(SUPPLEMENTAL TO SURVEY M-27)

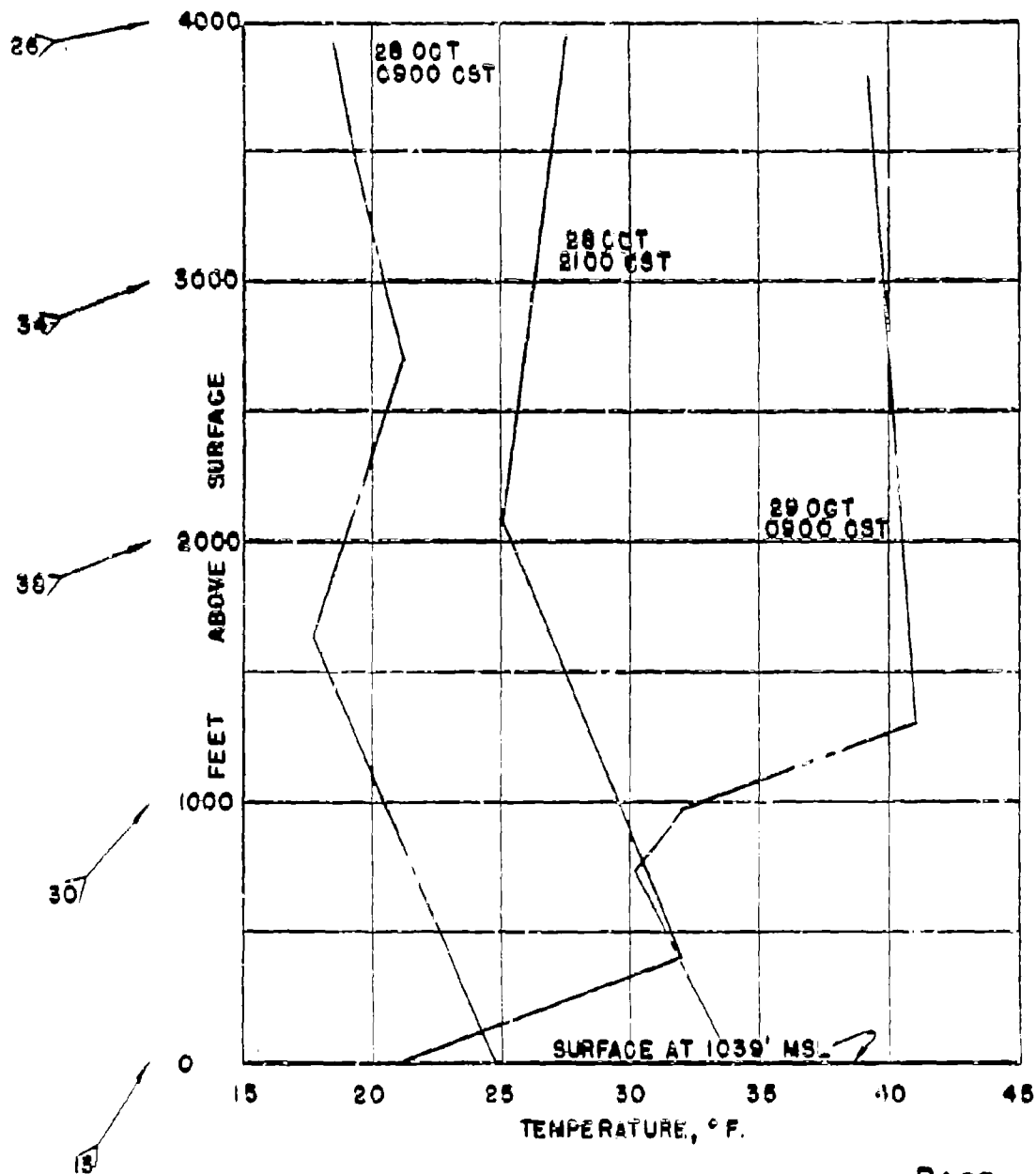
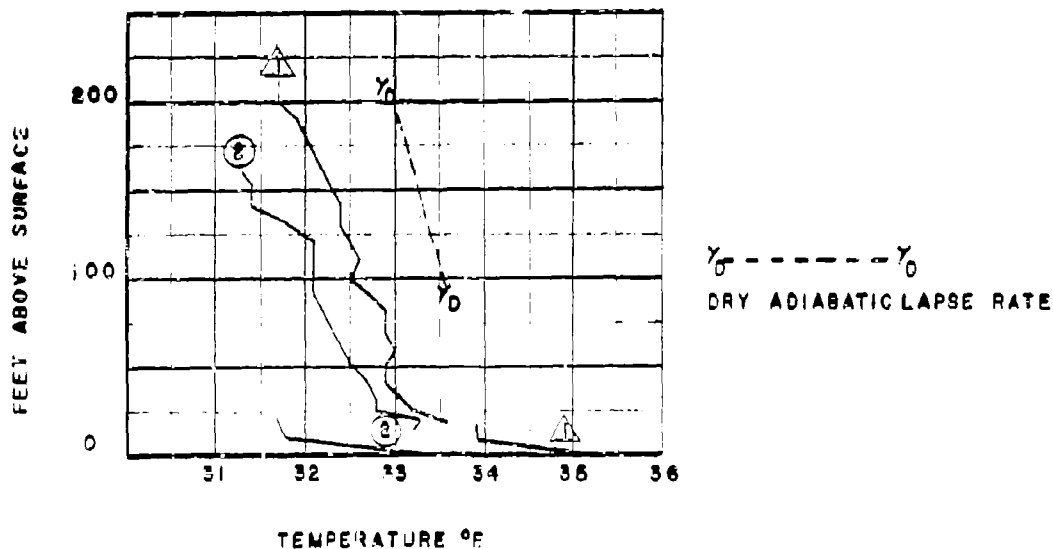

FIGURE A-7
TEMPERATURE SOUNDINGS
MINNEAPOLIS URBAN WIRESONDE
SURVEY M-27, 28 OCT 1952

- △ 2000 GST (2 HR 53 MIN AFTER SUNSET)
- ⊙ 2045 GST (3 HR 38 MIN AFTER SUNSET)



TEMPERATURE SURVEY W-27
(28 October 1952)

Synoptic Situation

A shallow polar continental air mass extended across the midcontinent from Hudson Bay to Texas, with cool clear weather in the resulting high-pressure system. At Minneapolis, near which lay the axis of this system, gradient winds were southwesterly and very light. However, 700-mb winds were northwesterly and much stronger, since the frontal system at this level was approaching the Dakota-Minnesota border.

Weather at Wold-Chamberlain Field (Minneapolis Airport)

<u>Time</u> <u>CST</u>	<u>Cloud Ht.</u> <u>(Ft.)</u>	<u>Sky</u> <u>Cover*</u>	<u>Visibility</u> <u>(Mi.)</u>	<u>Pressure</u> <u>(Mb)</u>	<u>Temp.</u> <u>(°F)</u>	<u>Dew</u> <u>Point</u>	<u>Wind</u> <u>Dir.</u>	<u>Wind</u> <u>Speed</u>
1830		Clear	15+	1028.8	35	13	WNW	7
1930		Clear	15+	1029.1	32	14	WSW	5
2030		Clear	15+	1029.1	29	12	WSW	8
2130		Clear	15+	1029.1	29	15	WNW	6
2230		Clear	15+	1028.8	27	15	SSW	2
2330	12000	Broken	15+	1027.8	25	16	SW	7

*Average cloudiness sunrise to sunset (Holman Field, St. Paul): 0%

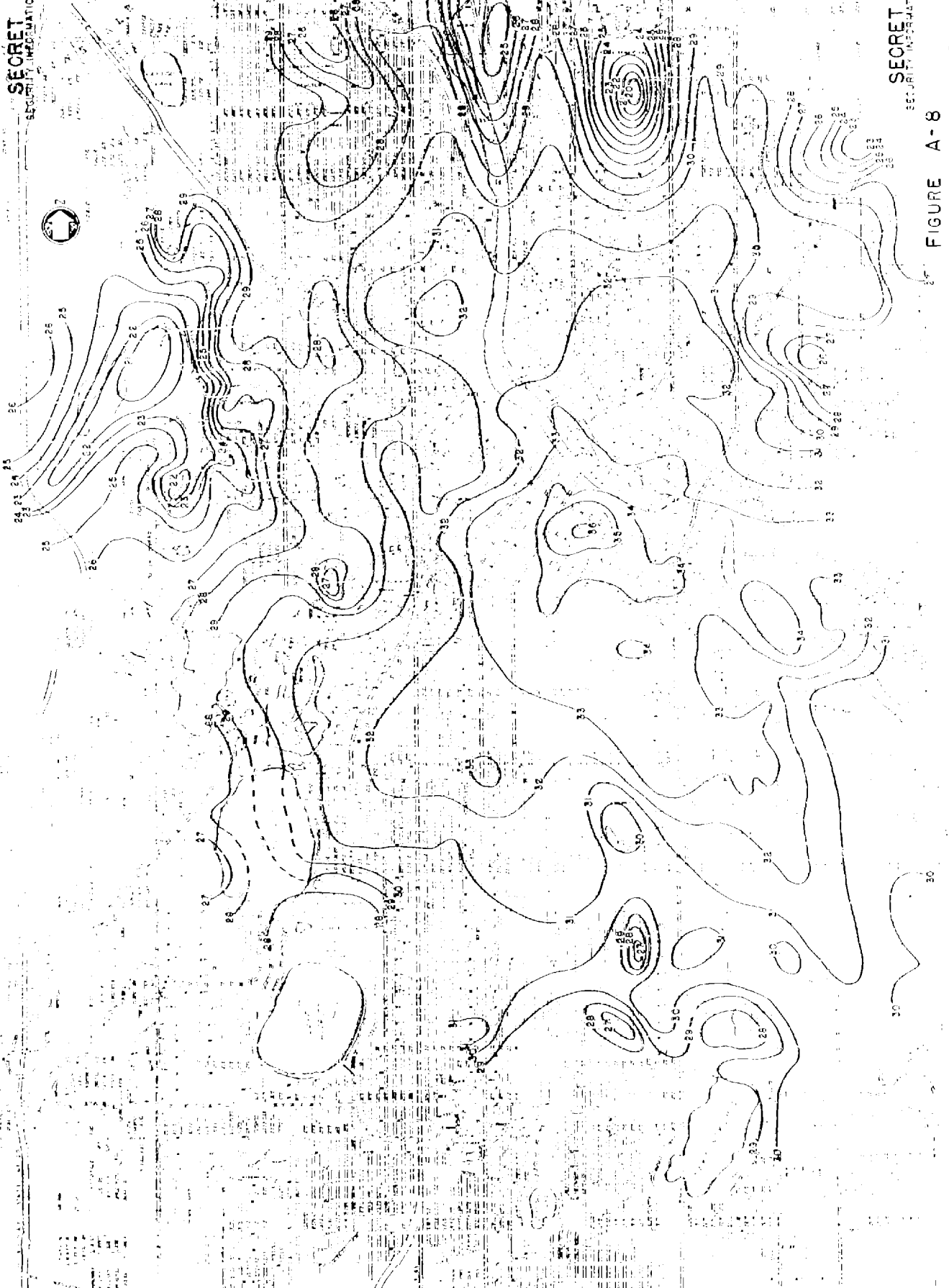
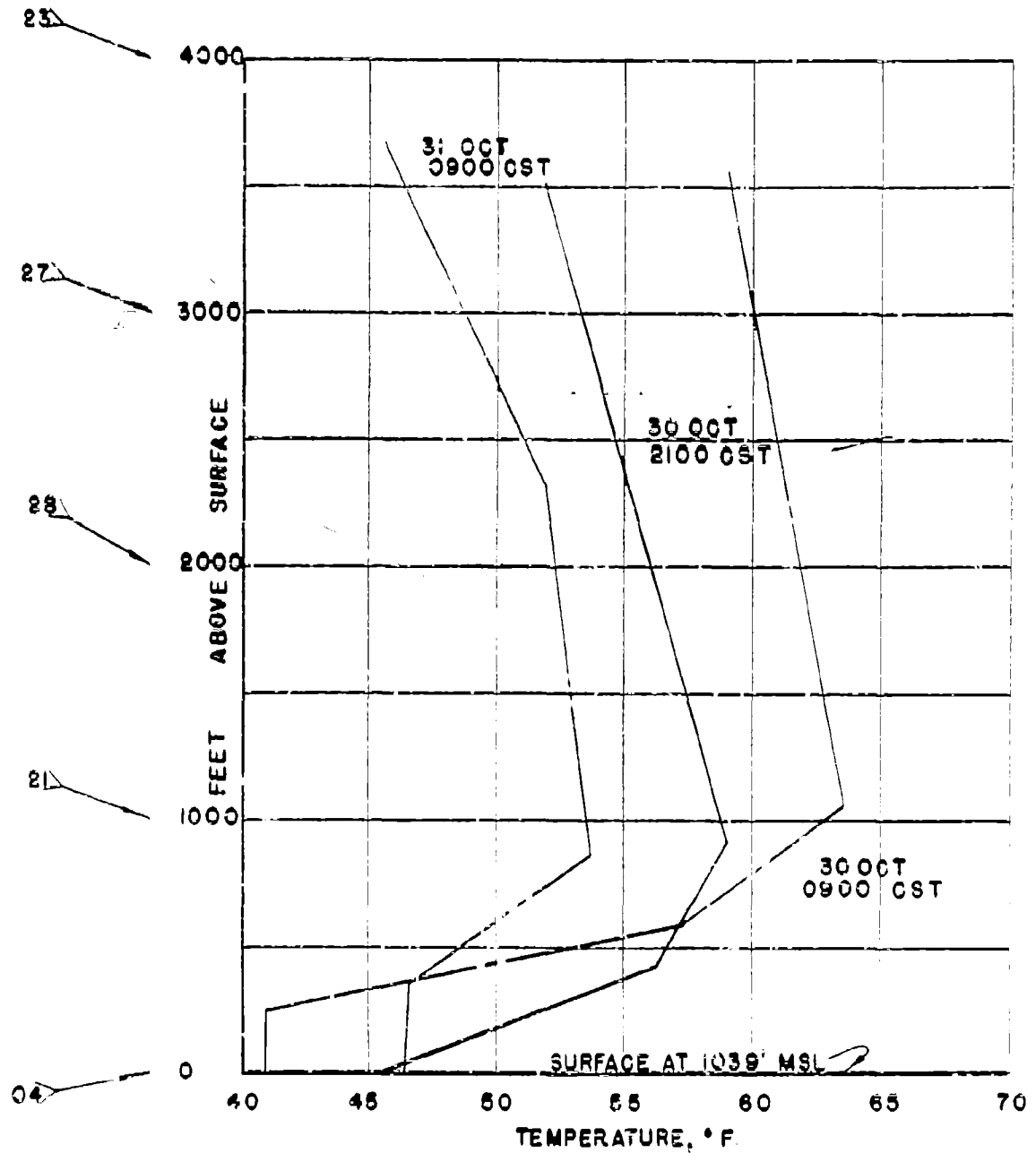

FIGURE A-8
TWO-METER AIR TEMPERATURE SURVEY
M-27 2100 HOURS
OCTOBER 28, 1952

FIGURE A-9

WINDS ALOFT
ST. CLOUD RAOB
30 OCTOBER 1952
2100 CST

TEMPERATURE SOUNDINGS
ST. CLOUD RAOB, 30 OCT. 1952
(SUPPLEMENTAL TO SURVEY M-29)



SECRET
SECURITY INFORMATION

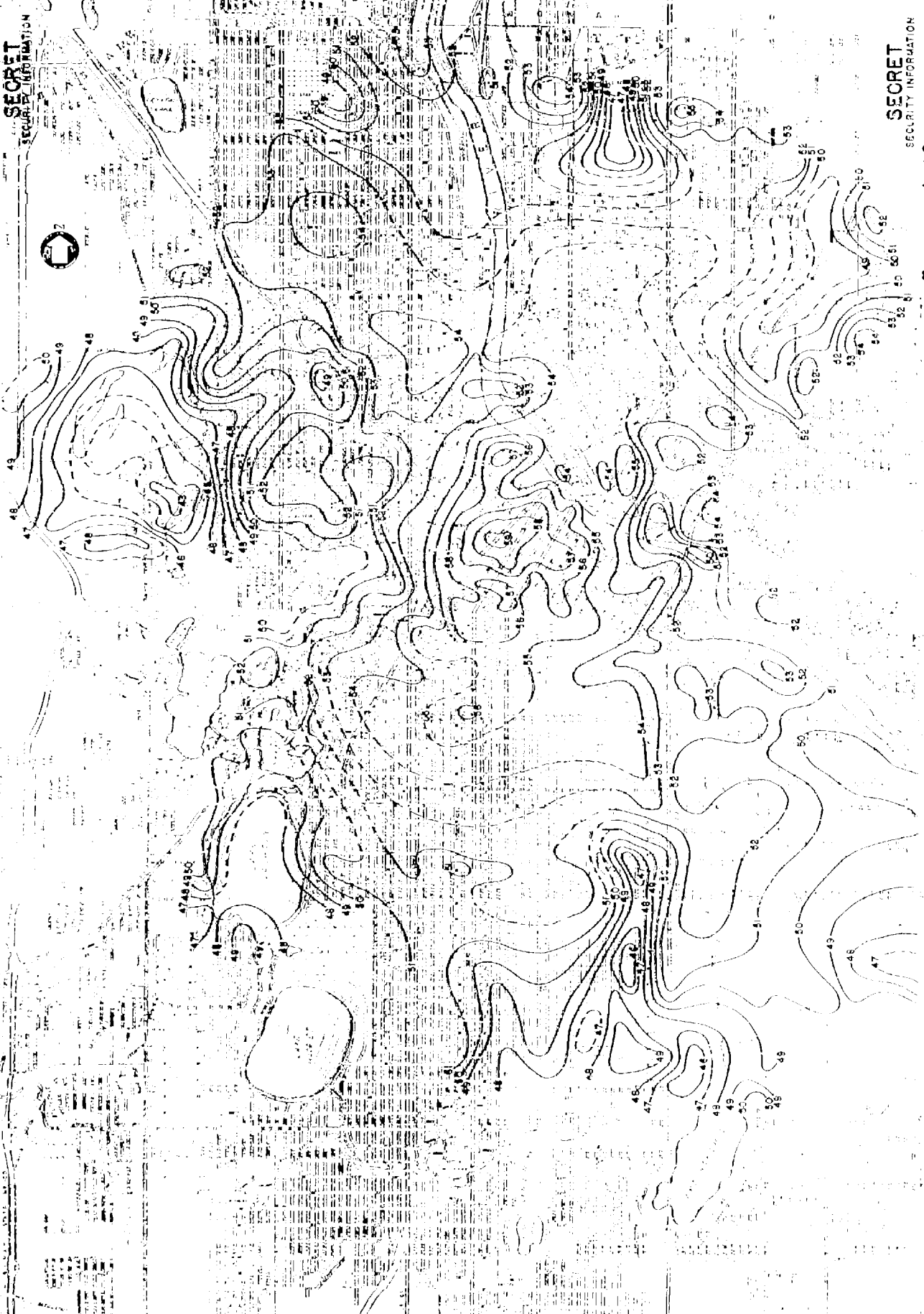

SECRET
SECURITY INFORMATION

FIGURE A-10
TWO-METER AIR TEMPERATURE SURVEY
M-29 2000 HOURS
OCTOBER 30, 1952
PAGE 98

SECRET

SECURITY INFORMATION



SECRET

SECURITY INFORMATION

FIGURE A-11

TWO-METER AIR TEMPERATURE SURVEY
14-29 2100 HOURS
OCTOBER 30, 1952

TEMPERATURE SURVEY M-29
(30 October 1952)

Synoptic Situation

Over Lake Superior 200 miles northeast of Minneapolis lay a 1001-mb low-pressure center, associated with a surface frontal system to the north of the Canadian border and a cold front aloft which extended southeastward into Kansas. One high cell was centered in Ontario, north of the low center, and a smaller high was centered at the Wyoming-South Dakota border. Over Minneapolis, circulation after the cold front aloft had passed brought maritime polar air, which had been considerably modified by its trajectory over the western mountains. Surface gradient winds were light southwesterly, and at the 700-mb level strong westerly winds were part of a high-index westerly flow over the entire country.

Weather at Wold-Chamberlain Field (Minneapolis Airport)

<u>Time</u> CST	<u>Cloud Ht.</u> (Ft.)	<u>Sky</u> <u>Cover*</u>	<u>Visibility</u> (Mi.)	<u>Pressure</u> (Mb)	<u>Temp.</u> (°F)	<u>Dew</u> <u>Point</u>	<u>Wind</u> <u>Dir.</u>	<u>Wind</u> <u>Speed</u>
1830	16000	Scattered	10	1004.7	57	28	SSW	4
	22000	Broken						
1930	15000	Broken	12	1004.4	54	29	SSE	9
2030	15000	Broken	12	1004.7	53	27	SSW	8
2130	15000	Broken	12	1004.7	50	27	SW	5
2230	15000	Scattered	15	1005.1	50	28	WSW	8
2330		Clear	15	1005.1	48	29	WSW	7

*Average cloudiness sunrise to sunset (Holman Field, St. Paul): 70%



DEPARTMENT OF THE ARMY
US ARMY RESEARCH, DEVELOPMENT AND ENGINEERING COMMAND
EDGEWOOD CHEMICAL BIOLOGICAL CENTER
5183 BLACKHAWK ROAD
ABERDEEN PROVING GROUND, MD 21010-5424

REPLY TO
ATTENTION OF:

JUN 20 2013

RDCB-DPC-RS

Q12
MEMORANDUM THRU Technical Director, Edgewood Chemical Biological Center (ECBC)
(RDCB-D/Mr. Joseph D. Wienand), 5183 Blackhawk Road, Aberdeen Proving Ground, MD
21010-5424

FOR Office of the Chief Counsel, US Army Research, Development and Engineering Command
(RDECOM)(AMSRD-CCF/Ms. Kelly Knapp), 3071 Aberdeen Boulevard, Aberdeen Proving
Ground, MD 21005-5424

SUBJECT: Operations Security/Freedom of Information Act (FOIA) Review Request

1. The purpose of this memorandum is to recommend the release of information in regard to RDECOM FOIA Request, FA-13-0041.
2. The ECBC received RDECOM FOIA Request FA-13-0041 from Ms. Kelly Knapp, RDECOM FOIA Officer. The request originated from Jennifer Randazzo, a historian with History Associate located in Rockville, Maryland.
3. The following unclassified documents were reviewed by subject matter experts from the ECBC and deemed releasable. However, the current distribution level must be changed with the Defense Technical Information Center (DTIC) prior to release:
 - a. AD-007261, Behavior of Aerosol Clouds Within Cities, Joint Quarterly Report Number Two, Oct – Dec 1952.
 - b. AD-e498515, Field Tests Concerning the Dissemination of Gas and Aerosol Clouds, Part IV: Nausta, dated Apr 1961.
4. The point of contact is Mr. Ronald L. Stafford, ECBC Security Specialist, (410) 436-6810 or ronald.l.stafford.civ@mail.mil.

MATTHEW A. SPAULDING
Security Manager